

we bring  
technologies  
together

hund  
WETZLAR

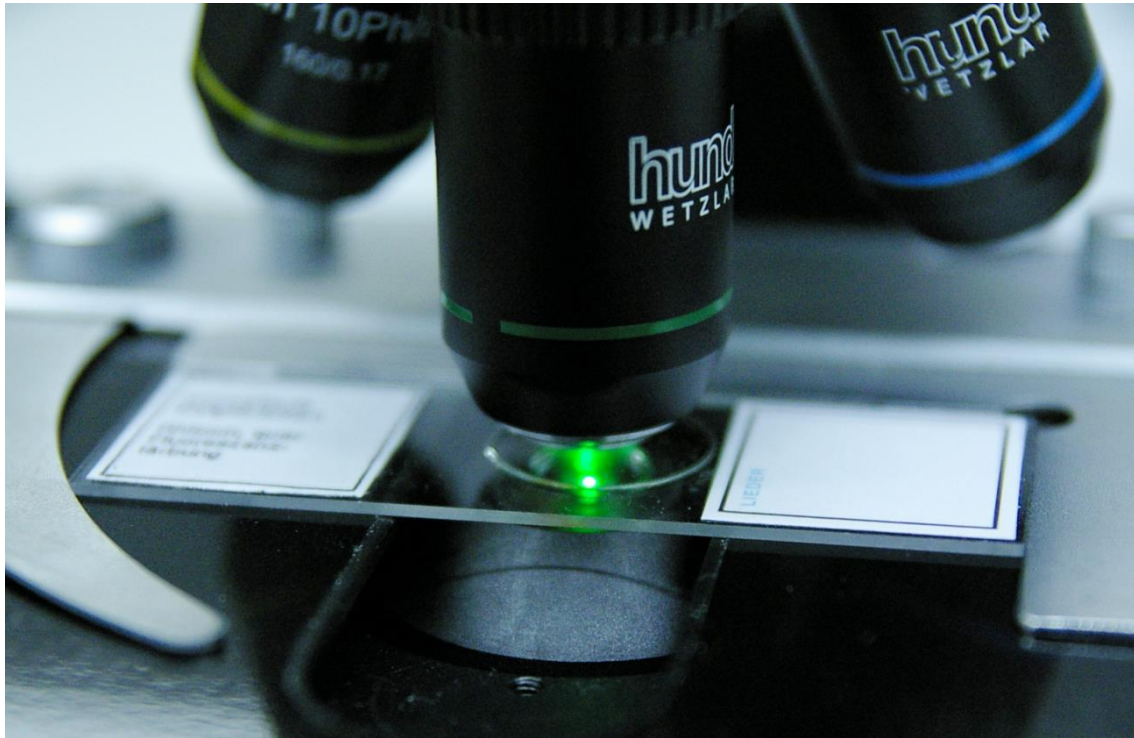

# Light Microscopes by Hund



- History
- The Microscope
- Contrasting Techniques
- Stand Systems
- Documentation

**μικρός (mikros): small**

**σκοπεῖν (skopein): to observe**



- **Zacharias Janssen (1588 – 1631):**  
1595: First compound microscope



de.wikipedia.org, public domain

- **Antoni van Leeuwenhoek (1632 – 1723):**  
High-quality single lenses, 270x, stained specimens



de.wikipedia.org, public domain



en.wikipedia.org, CC-SA 3.0

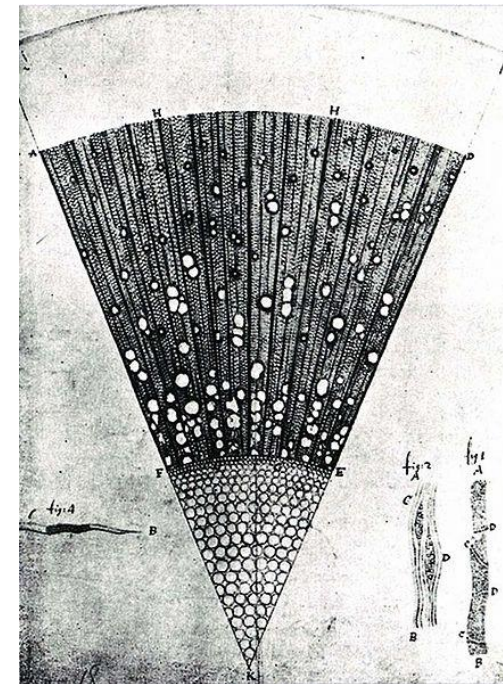

de.wikipedia.org, public domain

- **Robert Hooke (1635 – 1702):**

Compound microscope, oblique illumination:  
„Micrographia“, 1665

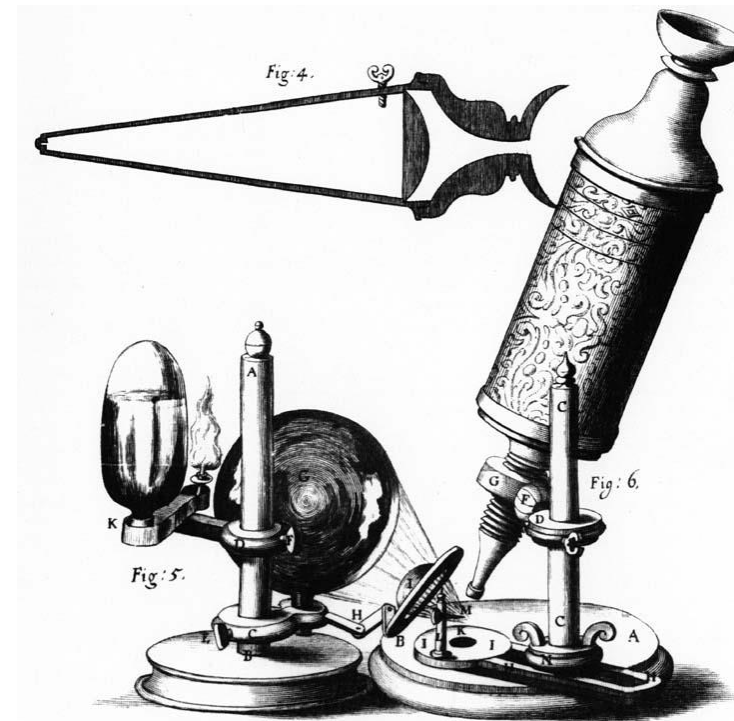

de.wikipedia.org, public domain

- **Étienne-Louis Malus (1755 – 1812):**

Publications on light refraction and polarisation



de.wikipedia.org, public domain

- **George Gabriel Stokes (1819 – 1903):**

Research on fluorescence, publications on light absorption



de.wikipedia.org, public domain

- **Ernst Abbe (1840 – 1905):**

1866: Cooperation with Carl Zeiss

1870: Imaging theory

$$\Delta x = \frac{\lambda}{NA_{\text{Objective}} + NA_{\text{Condenser}}}$$

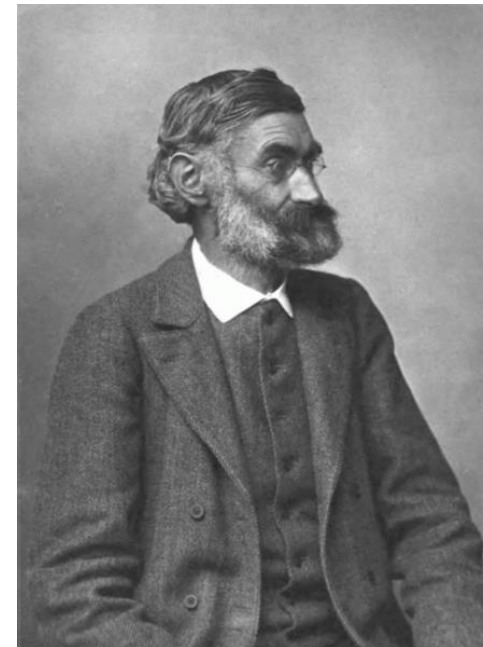

de.wikipedia.org, public domain



- **Paul Ehrlich (1845 – 1915):**

Advancement of staining methods for immunology

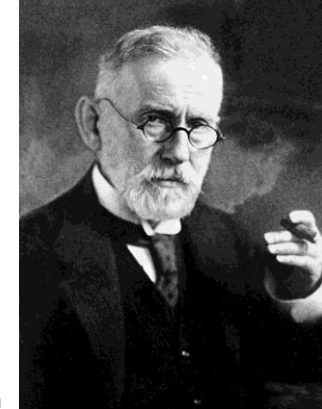

de.wikipedia.org, public domain

- **Hans Christian Gram (1853 – 1938):**

Gram staining of bacteria



Source unknown

- **Frederik Zernike (1888 – 1966):**

1930: Invention of phase contrast microscopy

1941: First commercial instrument (Zeiss)

1953: Nobel Prize in Physics



de.wikipedia.org, public domain

- **Marvin Minsky (1927 – 2016):**  
1955: Confocal microscope  
1956: Term „Artificial intelligence“

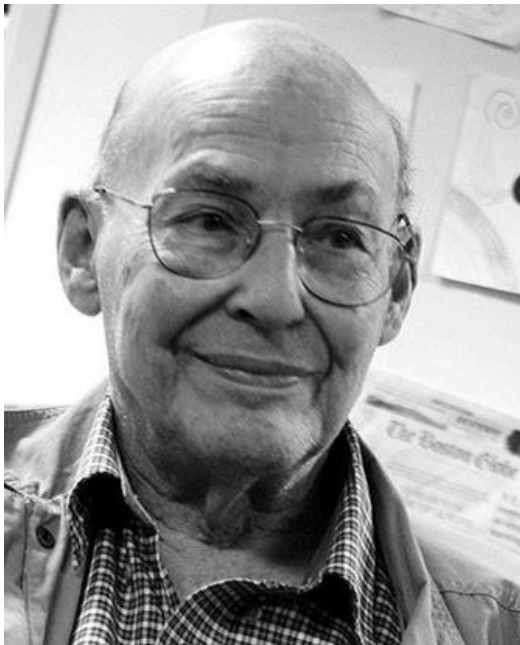

en.wikipedia.org, CC-A-3.0

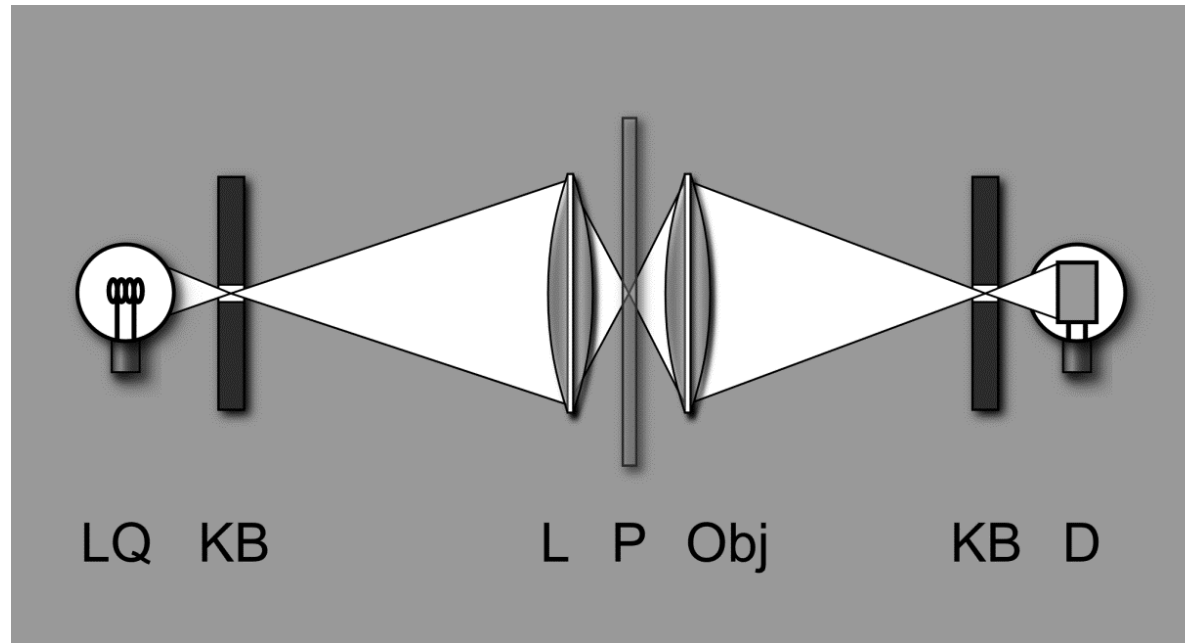

- **Stefan W. Hell (\*1962):**

2000: STED microscope

2001: MPI for Biophysical Chemistry, Göttingen

2014: Nobel Prize in Chemistry



de.wikipedia.org, CC-SA-3.0

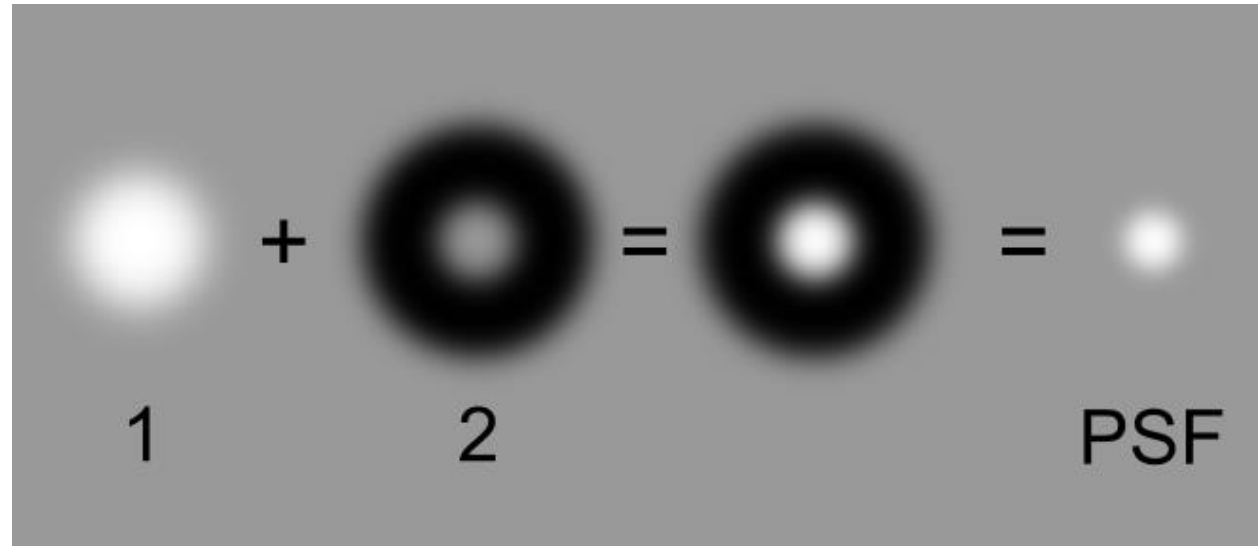



## Total Magnification

- How large is the observed image?
- Determined by objective, eyepiece and (optional) tube factor

## Resolving Power

- How much detail is contained in the image?
- Important: numerical apertures of objective and condenser

## Contrast

- Are object details well discernible?
- There are different contrasting techniques

# The Microscope: Parameters

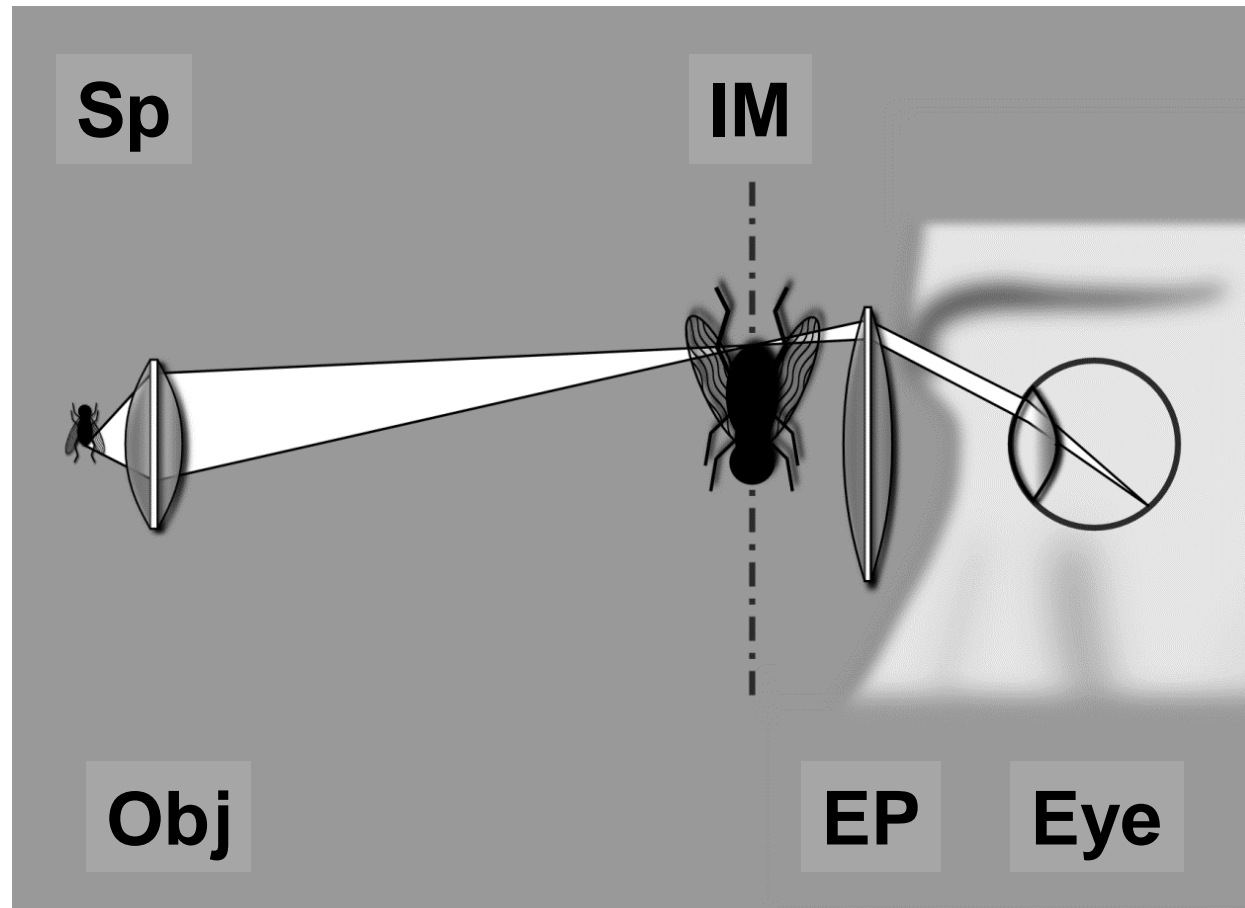

**Sp:** Specimen

**Obj:** Objective

**IM:** Intermediate image

**EP:** Eyepiece

## Total Magnification

- How large is the observed image?
- Determined by objective, eyepiece and (optional) tube factor

M =



X



## Resolving Power

- How much detail is contained in the image?
- Important: numerical apertures of objective and condenser

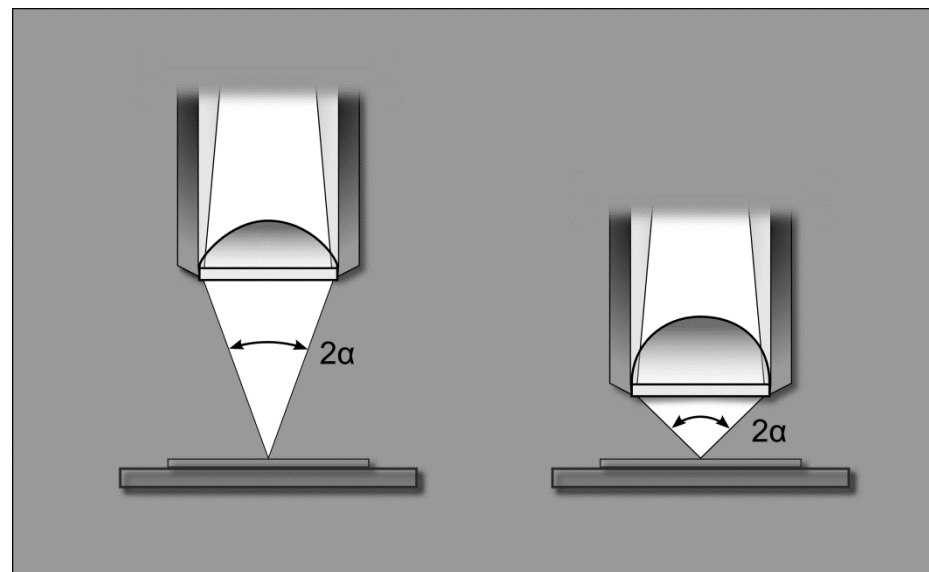
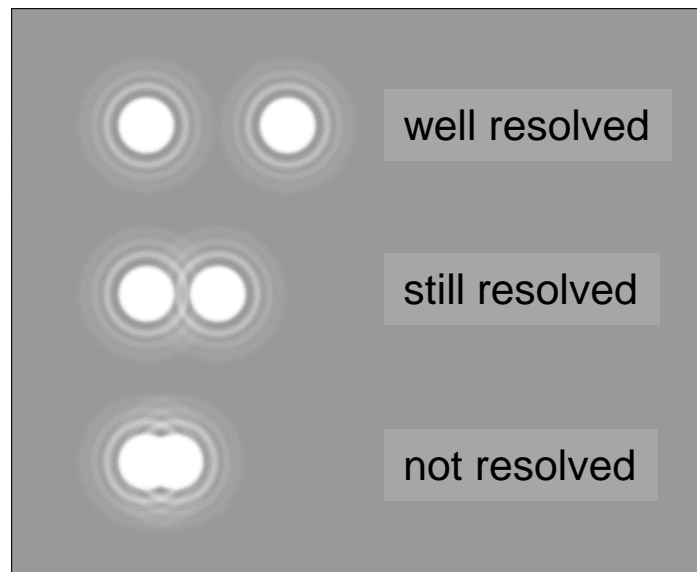



## Resolving Power

- How much detail is contained in the image?
- Important: numerical apertures of objective and condenser

$$\Delta x = \frac{\lambda}{NA_{\text{Objective}} + NA_{\text{Condenser}}}$$

## Resolving Power

Useful magnification of a microscope:

$$M_{\text{useful}} = (500 \dots 1'000) \times NA$$

For an objective with NA 1.25, one gets:

$$M_{\text{useful, max}} = 1'250,$$

can be realized e. g. with a 100:1 objective and 12.5x eyepiece(s)

## Resolving Power

Magnifications larger than useful: empty magnification

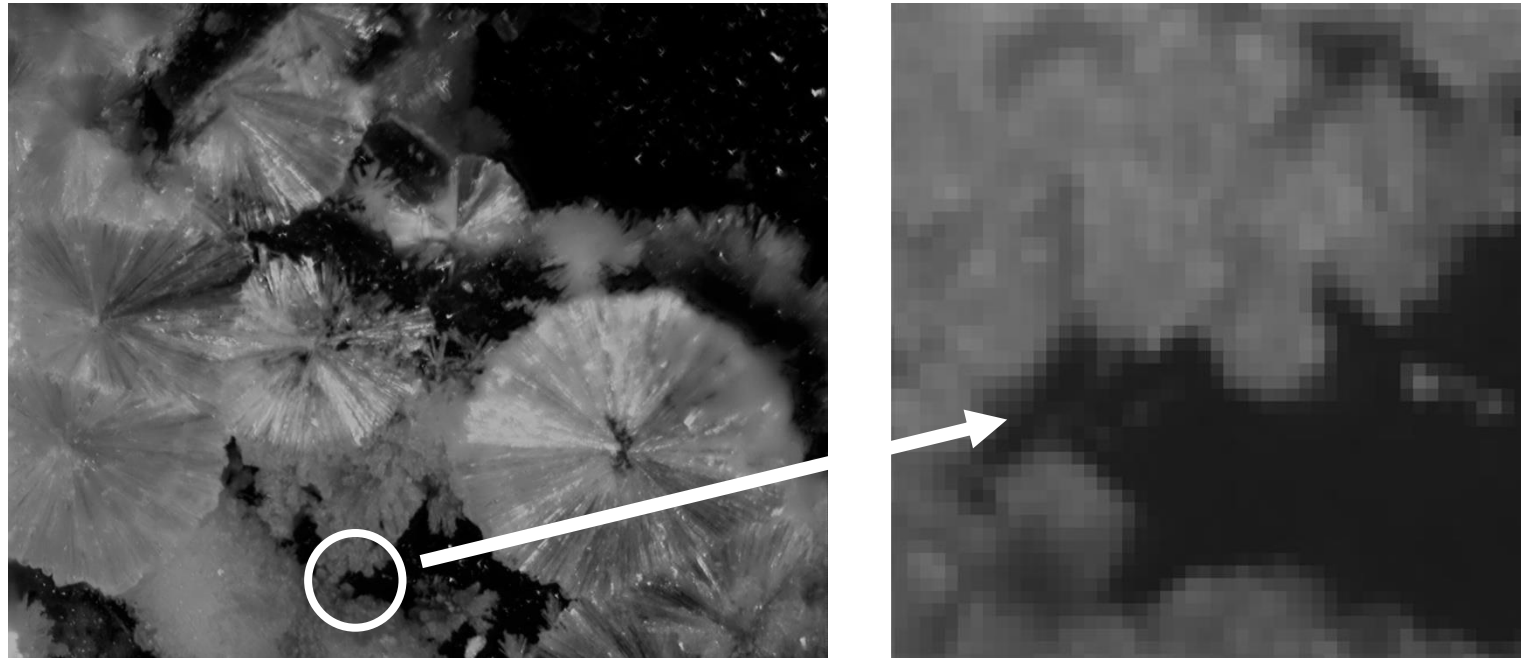

## Resolving Power

For numerical apertures  $\geq 1$ : Oil immersion

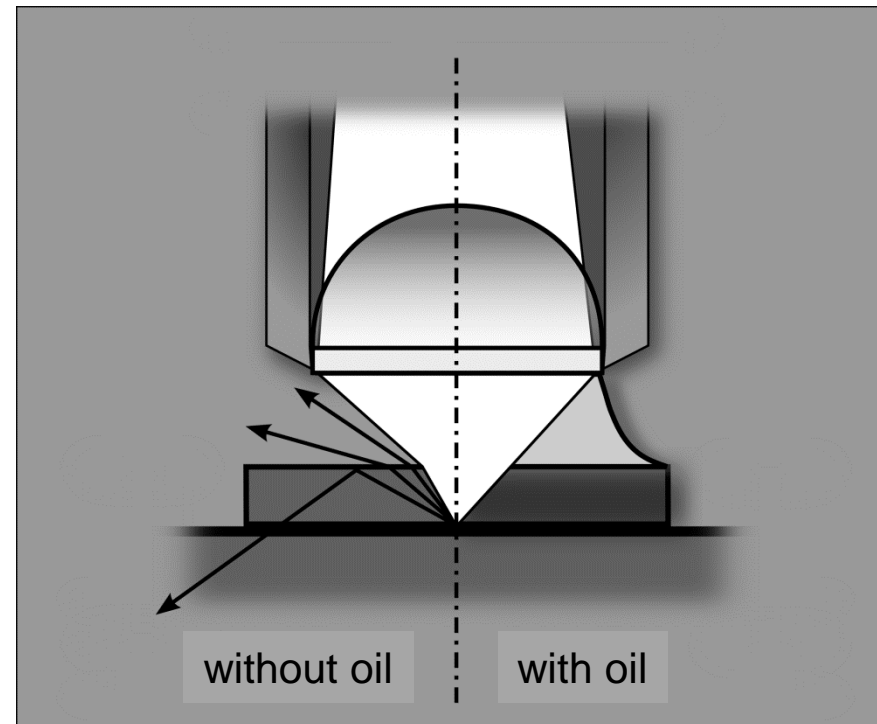



## Optical correction: Achromatic objectives

### Chromatic aberrations:

- longitudinal
- lateral



de.wikipedia.org, CC-SA-3.0

## Optical correction: Achromatic objectives

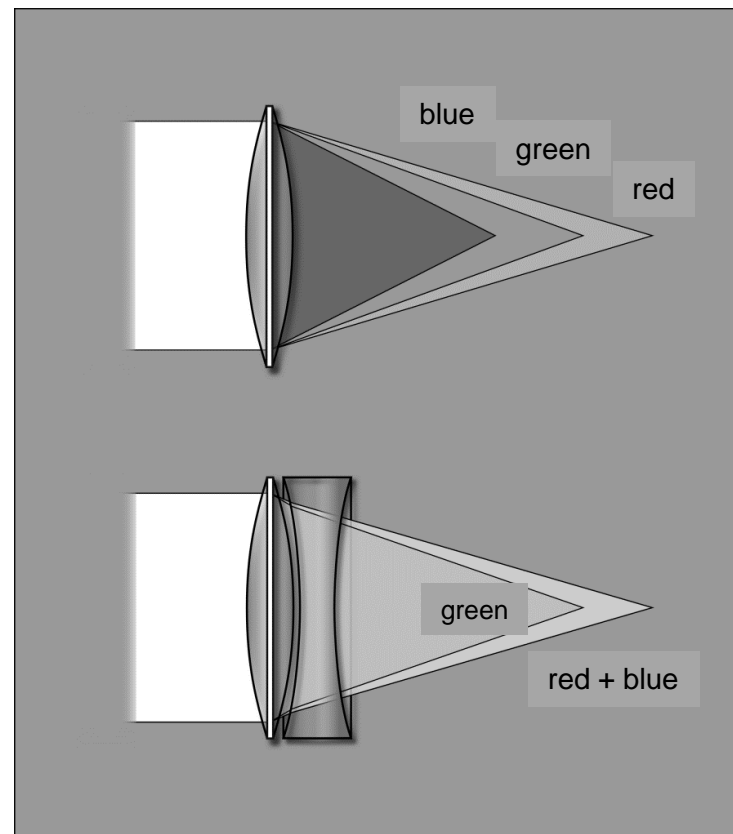

## Optical correction: Plan objectives for flat images

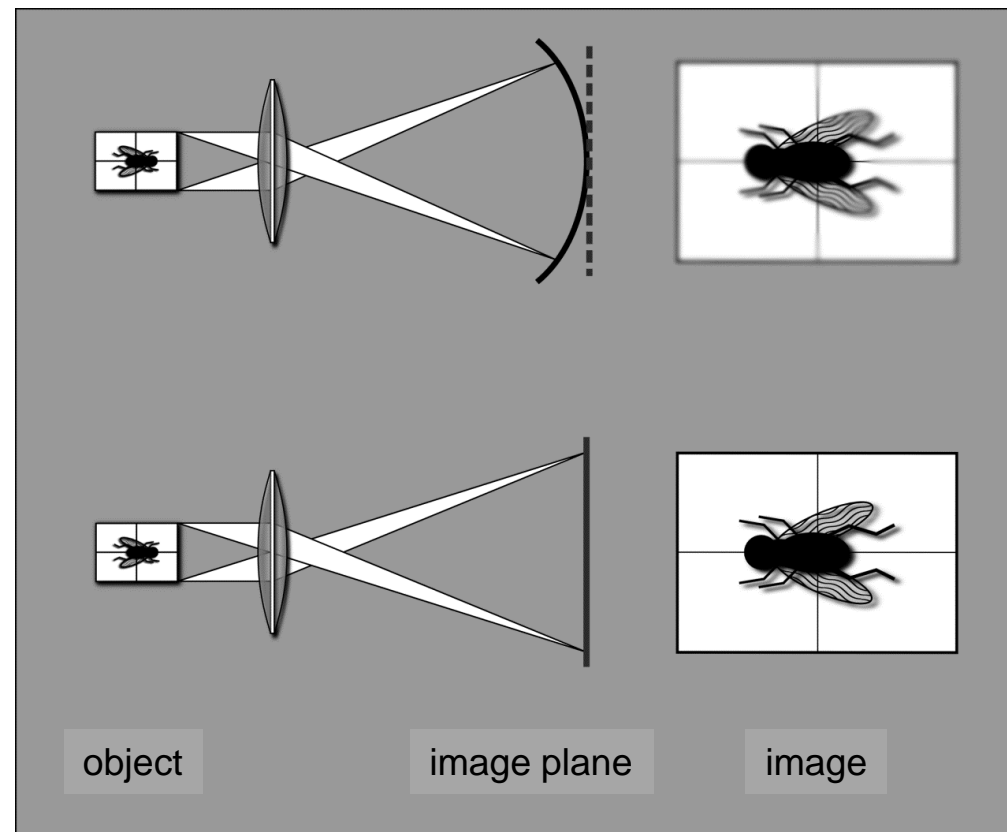

# Brightfield (BF) Microscopy

- High-contrast specimens with intrinsic colours
- Alternative: Staining (disadvantage: cells †)
- Example: Stained tissue sections and smears
- Specimen is screened ‘like a diapositive’

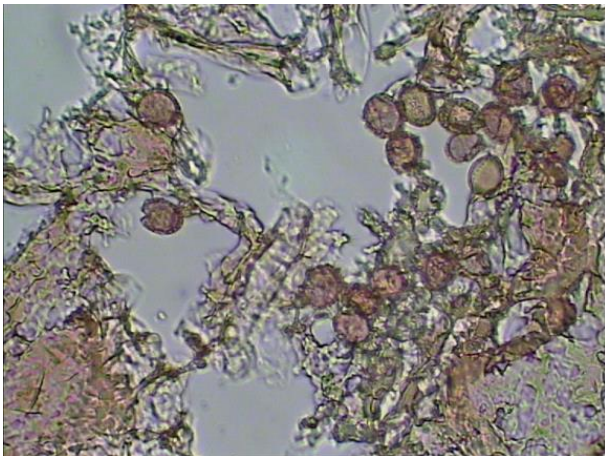

Mushroom, intrinsic colour

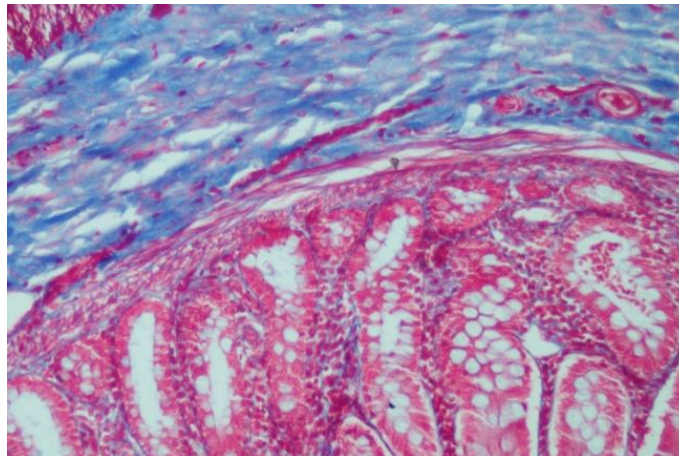

Duodenum section, AZAN staining

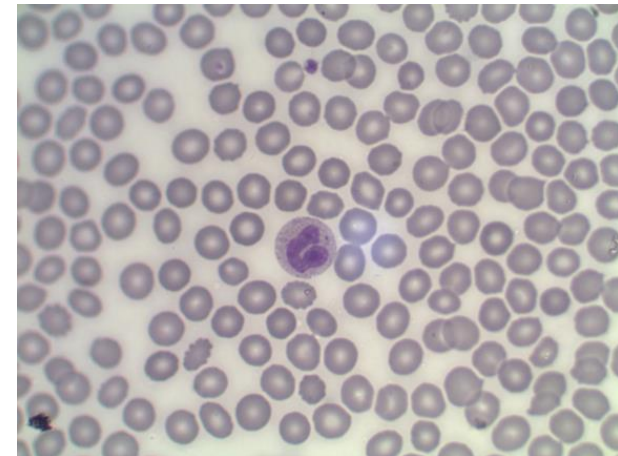

Blood smear, Giemsa staining



# Brightfield (BF) Microscopy

Examples: Intrinsic colours/sufficient contrast

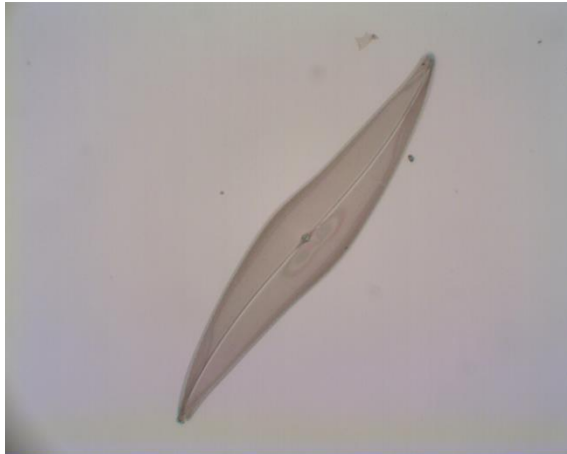

Diatom

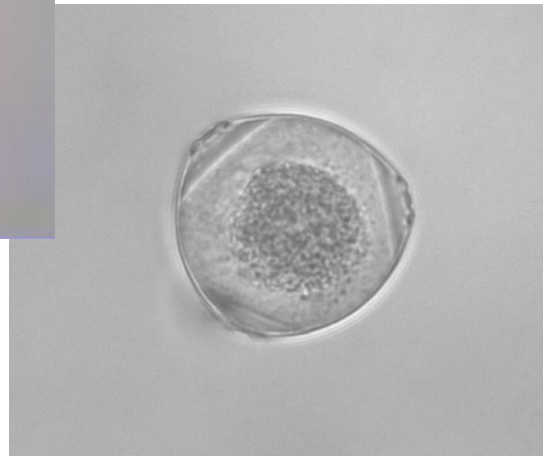

Hazel pollen

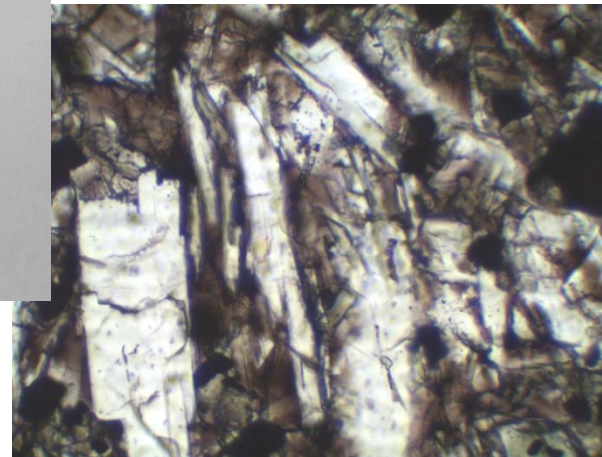

Thin section (basalt)

# Brightfield (BF) Microscopy

## Examples: Stained specimens

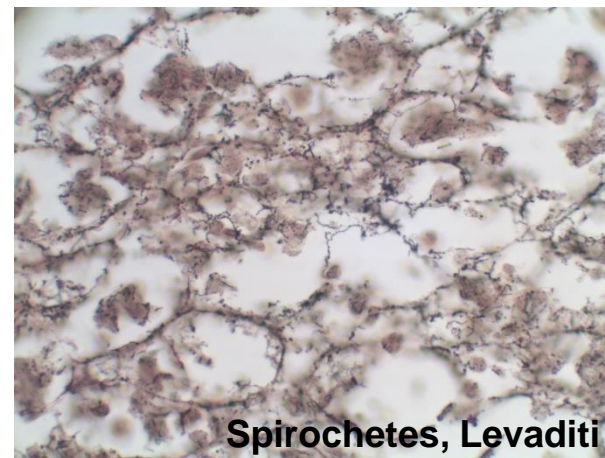
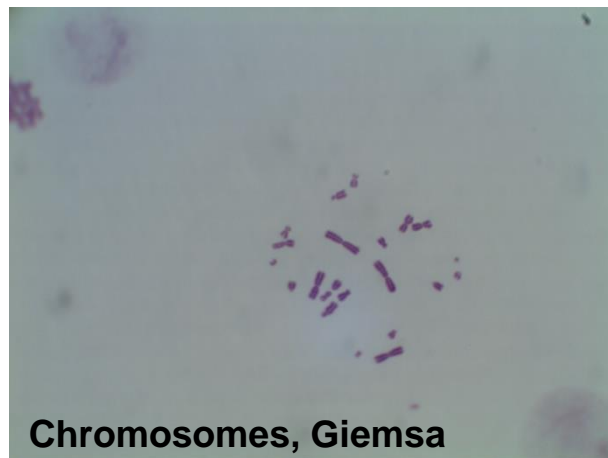
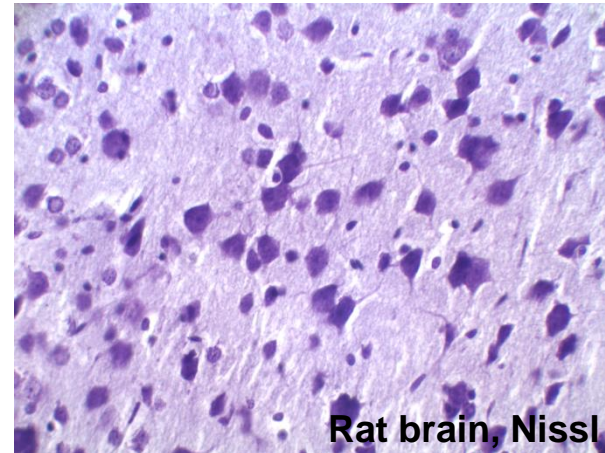
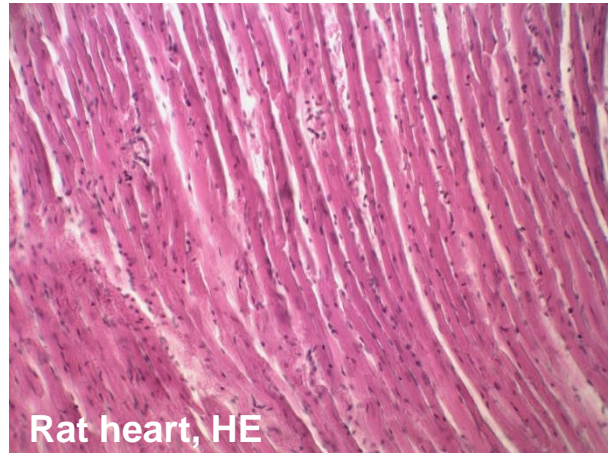

# Brightfield (BF) Microscopy

## Opaque specimens: Incident-light microscopy

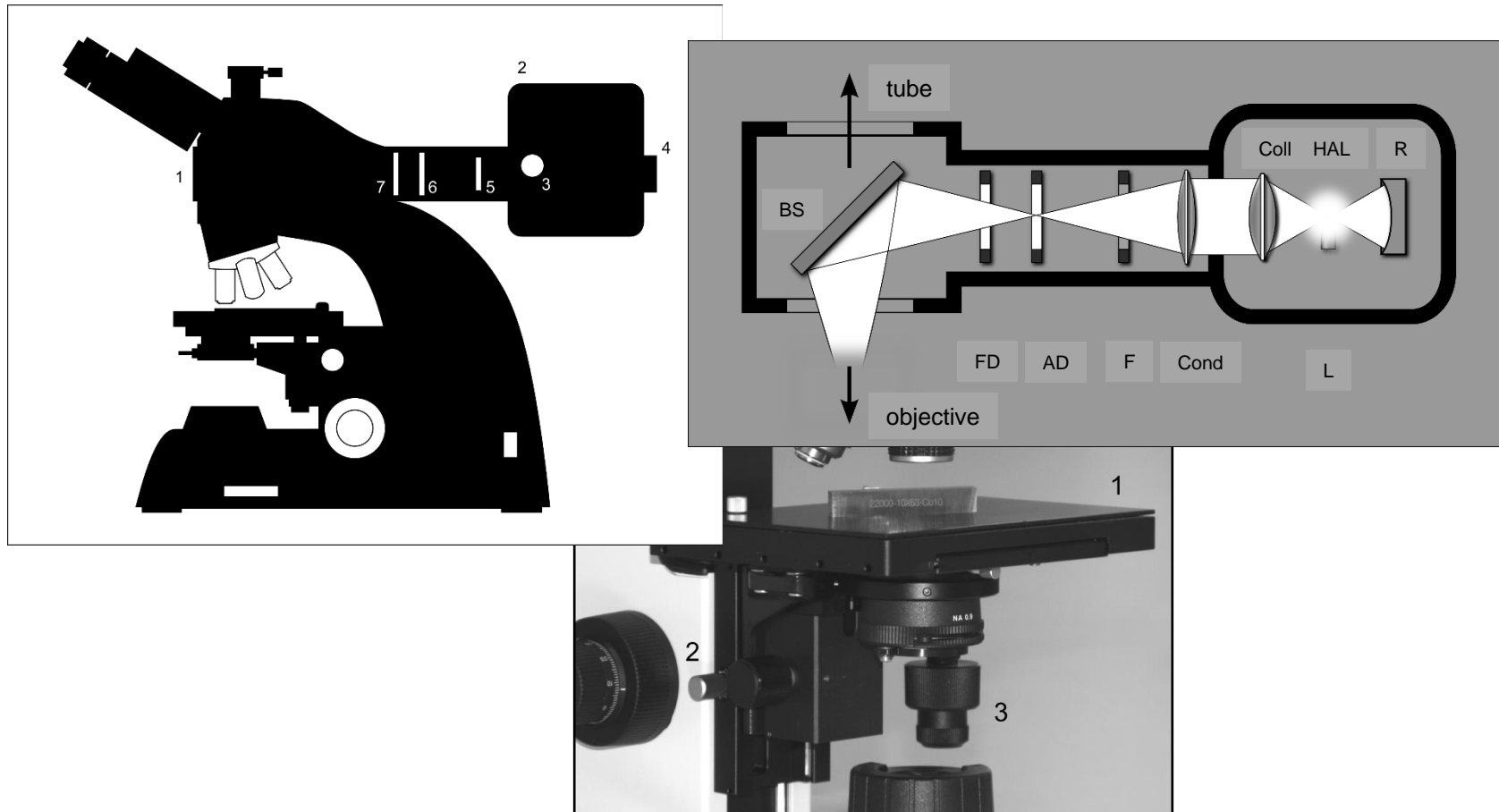



# Brightfield (BF) Microscopy

## Examples: Incident-light microscopy

Composite material, 100x

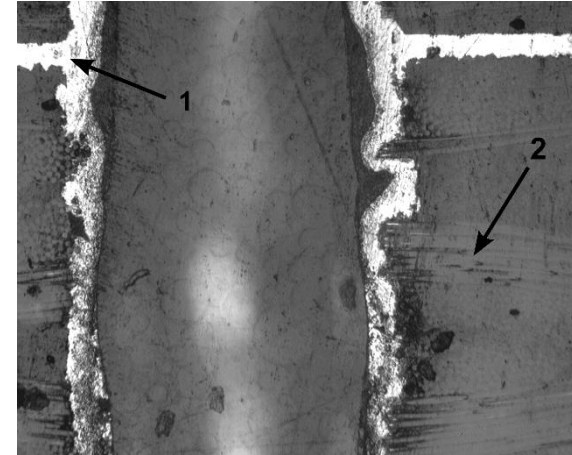
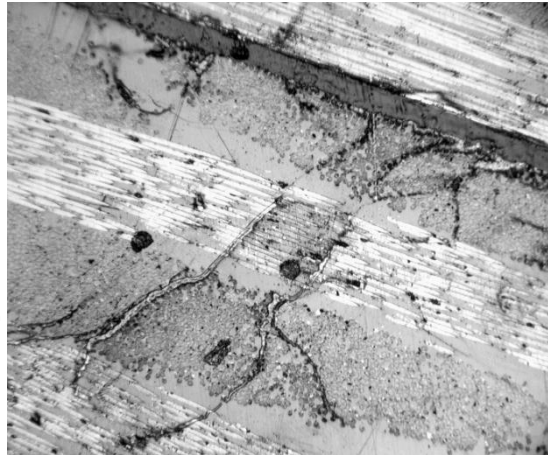

PCB: polished section, 100x

Vinyl record, 40x

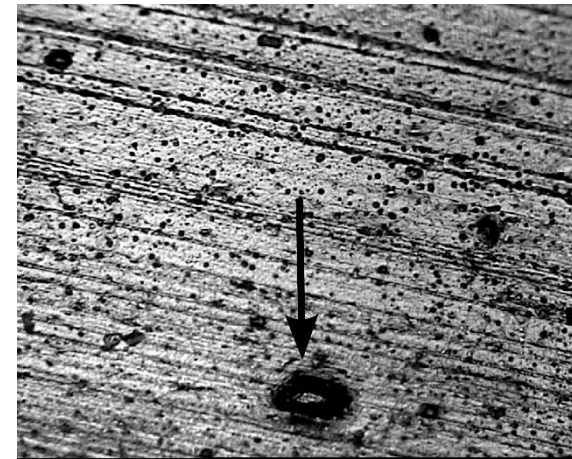
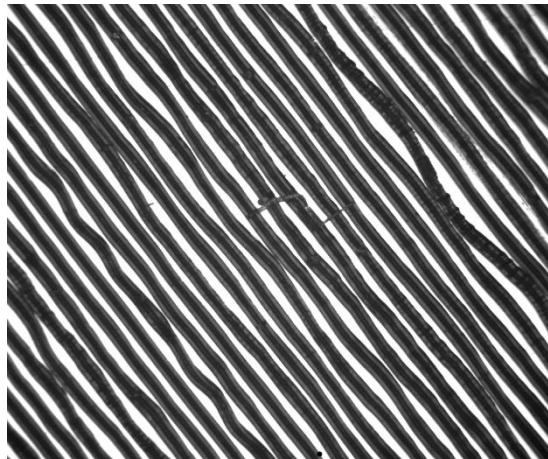

Tyre rubber, 100x

# Brightfield (BF) Microscopy

Examples: Stereo microscopy, flexible illumination

Watch movement

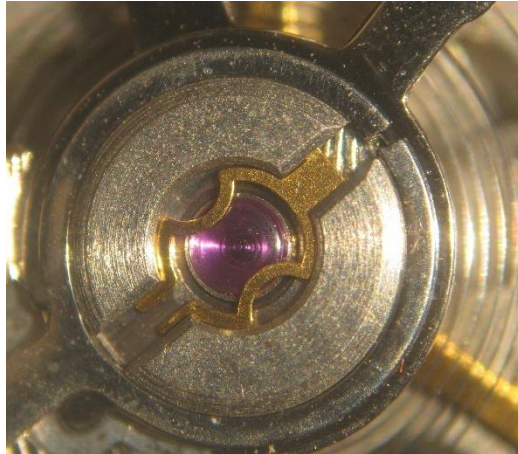

Light guide

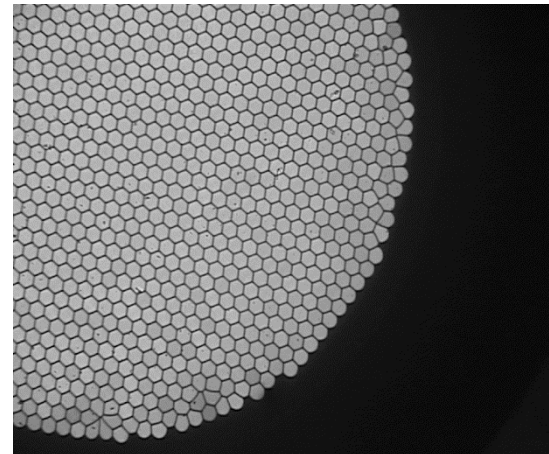

Buds with mites



Nail fold capillaries





# Phase Contrast (PH) Microscopy

- Low-contrast, thin specimens
- Staining: Not possible/not desirable
- Example: Examination of saliva, urinary sediment
- BF microscope with special objectives and condenser annuli

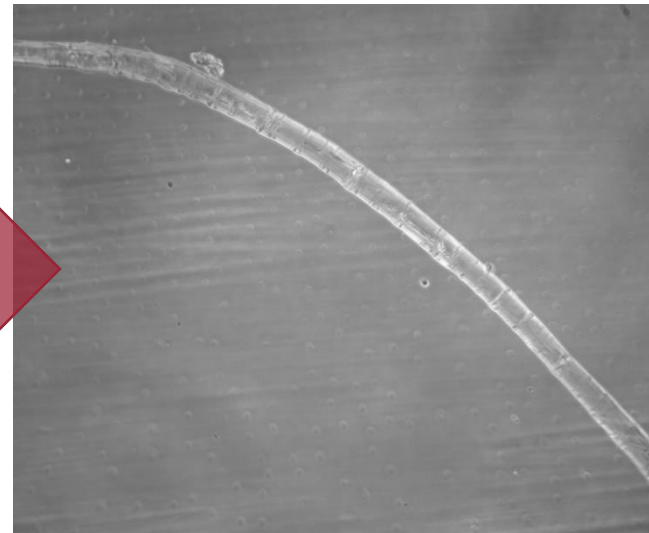
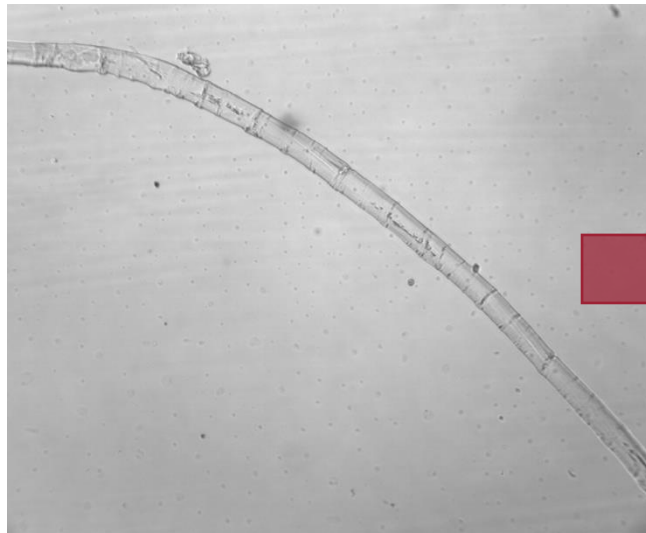

# Phase Contrast (PH) Microscopy

**One** annulus for **each** phase objective!

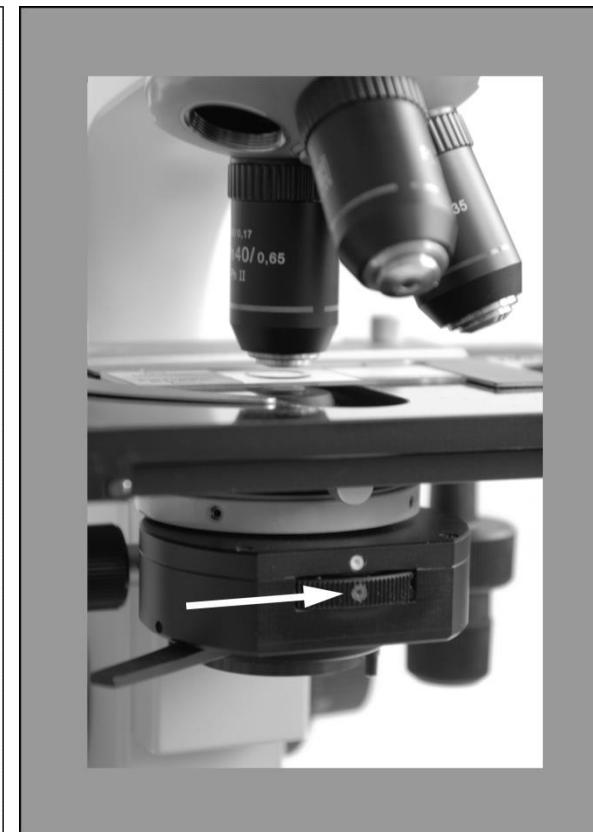
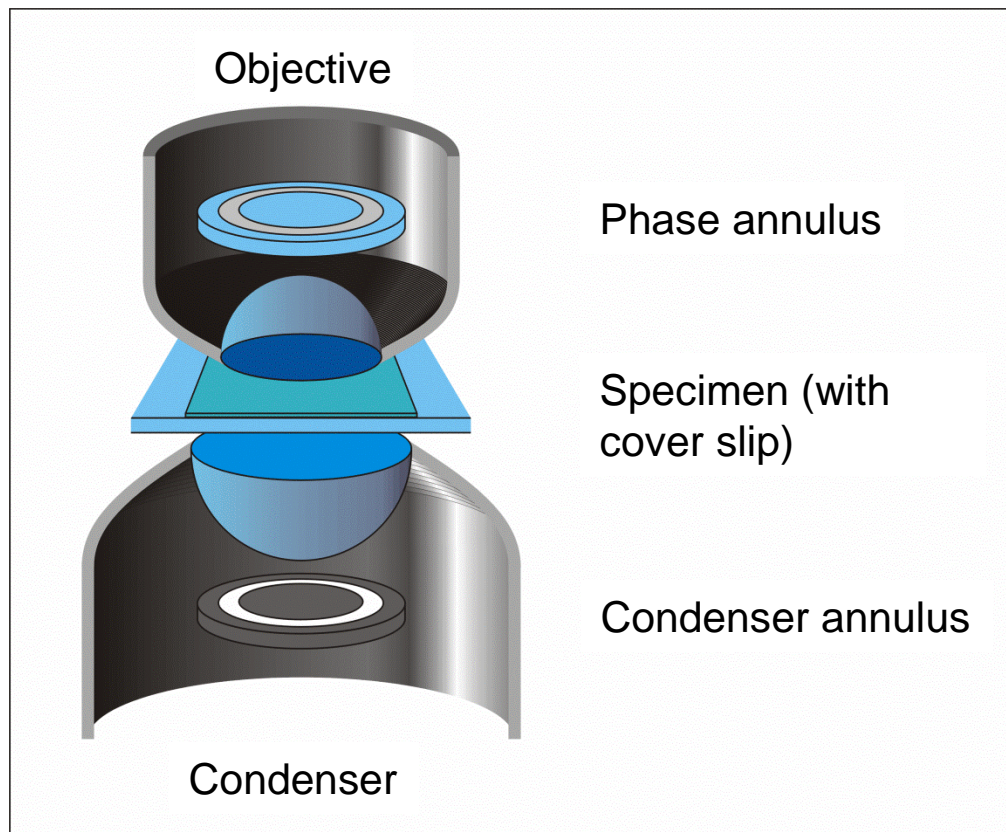

# Phase Contrast (PH) Microscopy

Example: Epithelial cells

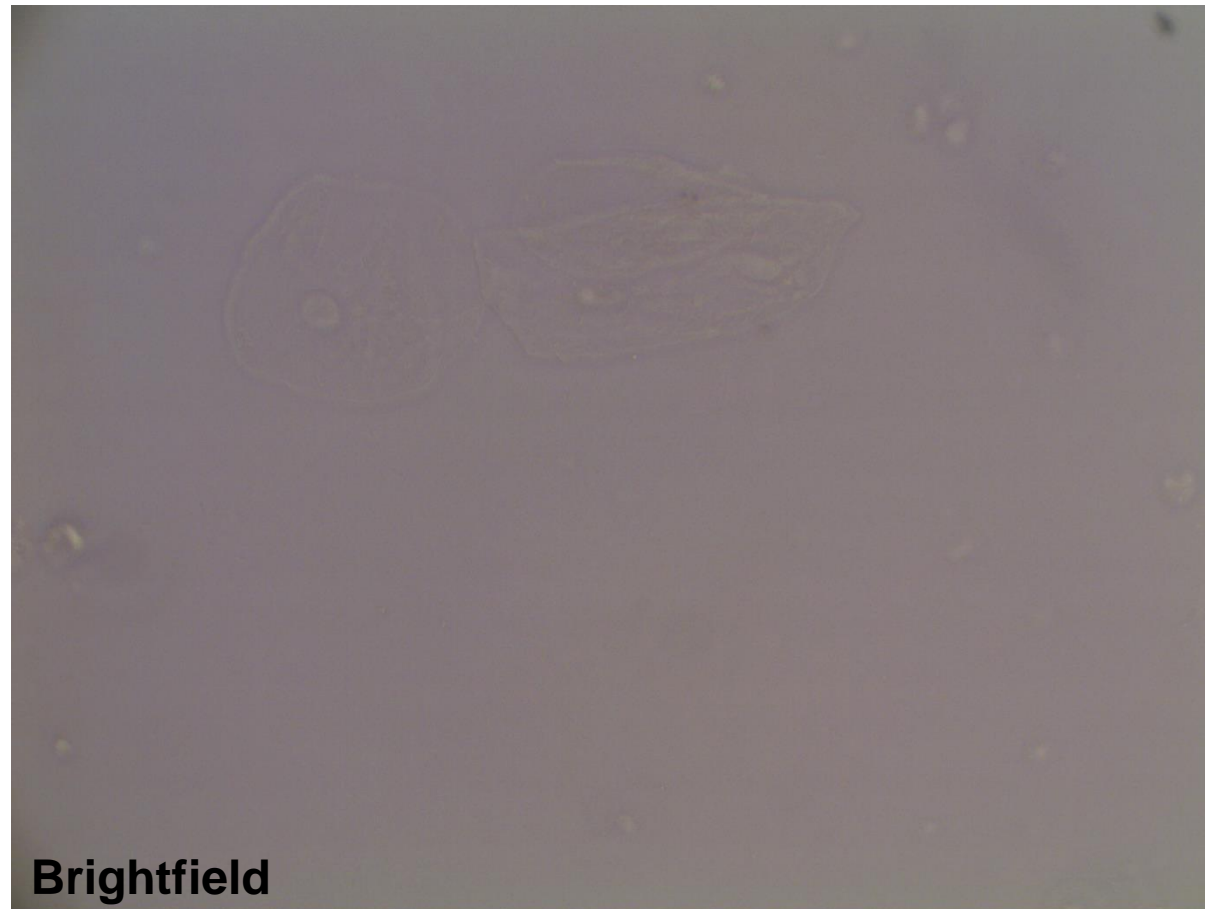

# Phase Contrast (PH) Microscopy

## Example: Epithelial cells



# Phase Contrast (PH) Microscopy

Example: Epithelial cells





# Phase Contrast (PH) Microscopy

## Example: Urinary sediment

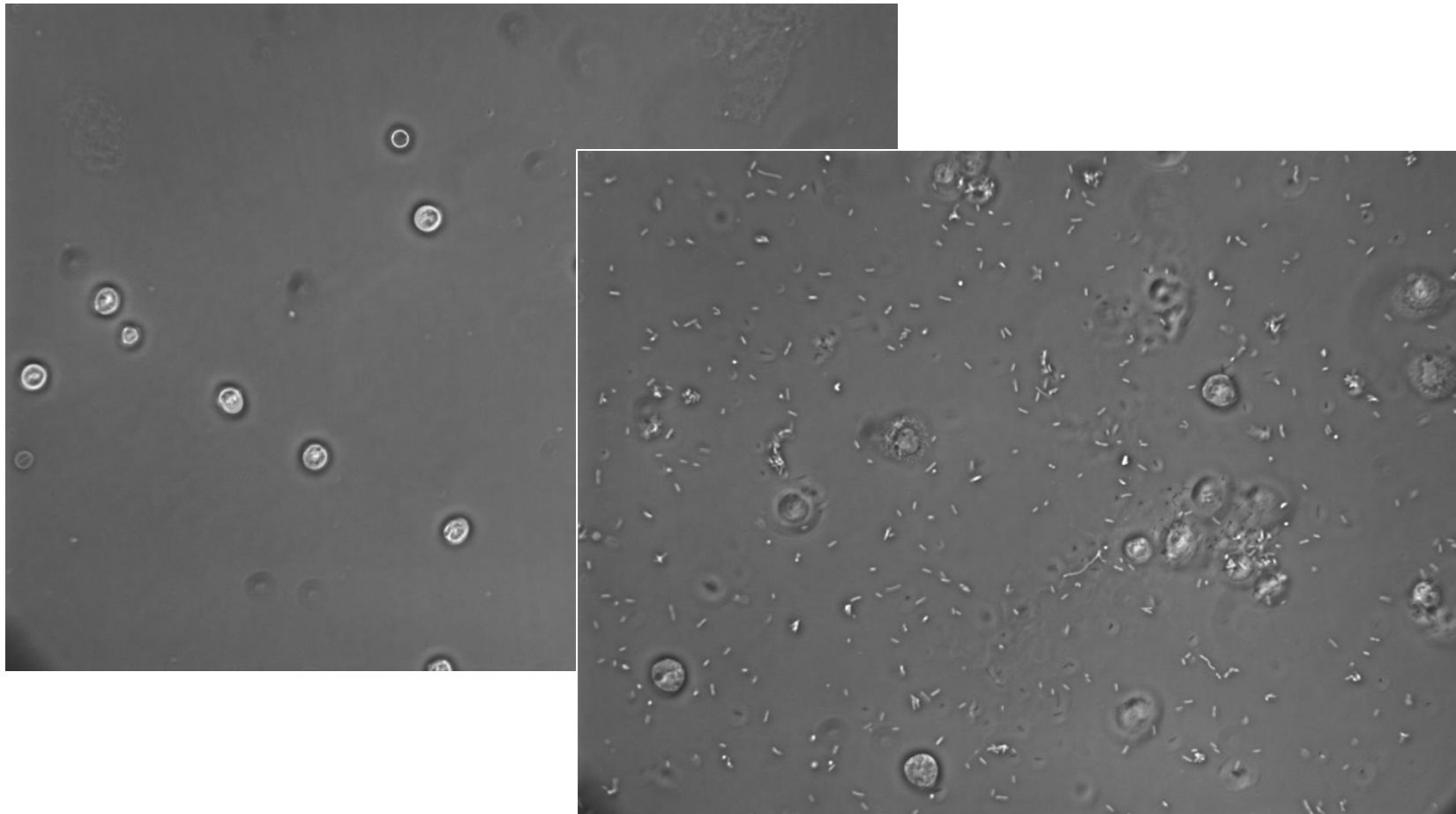



# Darkfield (DF) Microscopy

- Low-contrast specimens
- Staining: Not possible/not desirable
- Example: Examination for spirochetes
- BF microscope with special condenser annulus or condenser

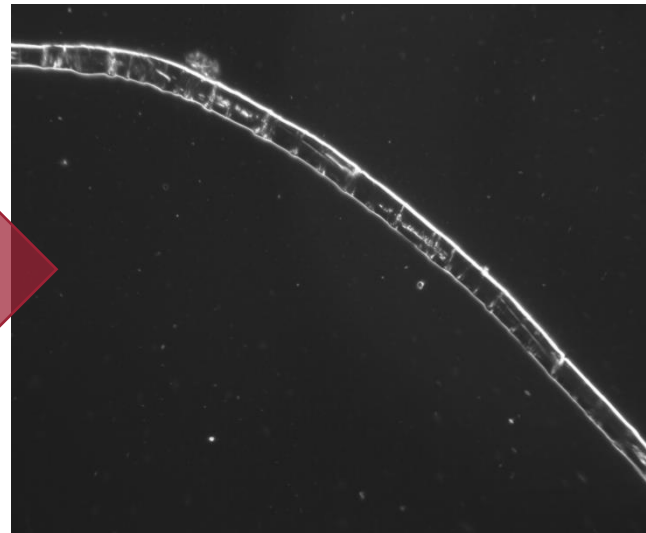
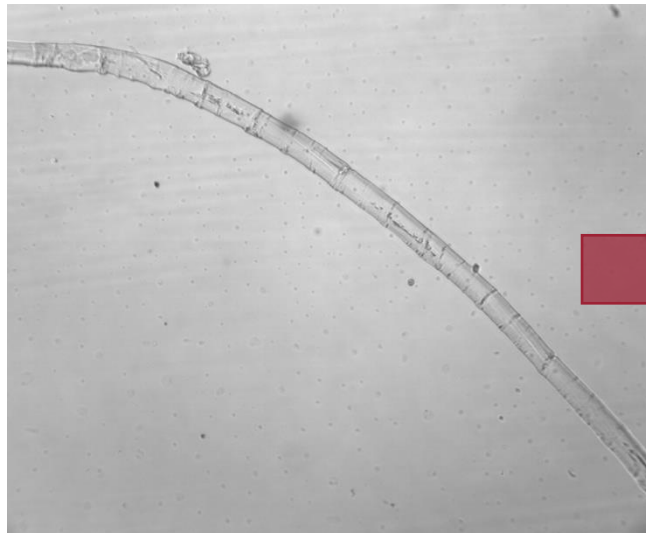

# Darkfield (DF) Microscopy

Illumination with **hollow** light cone

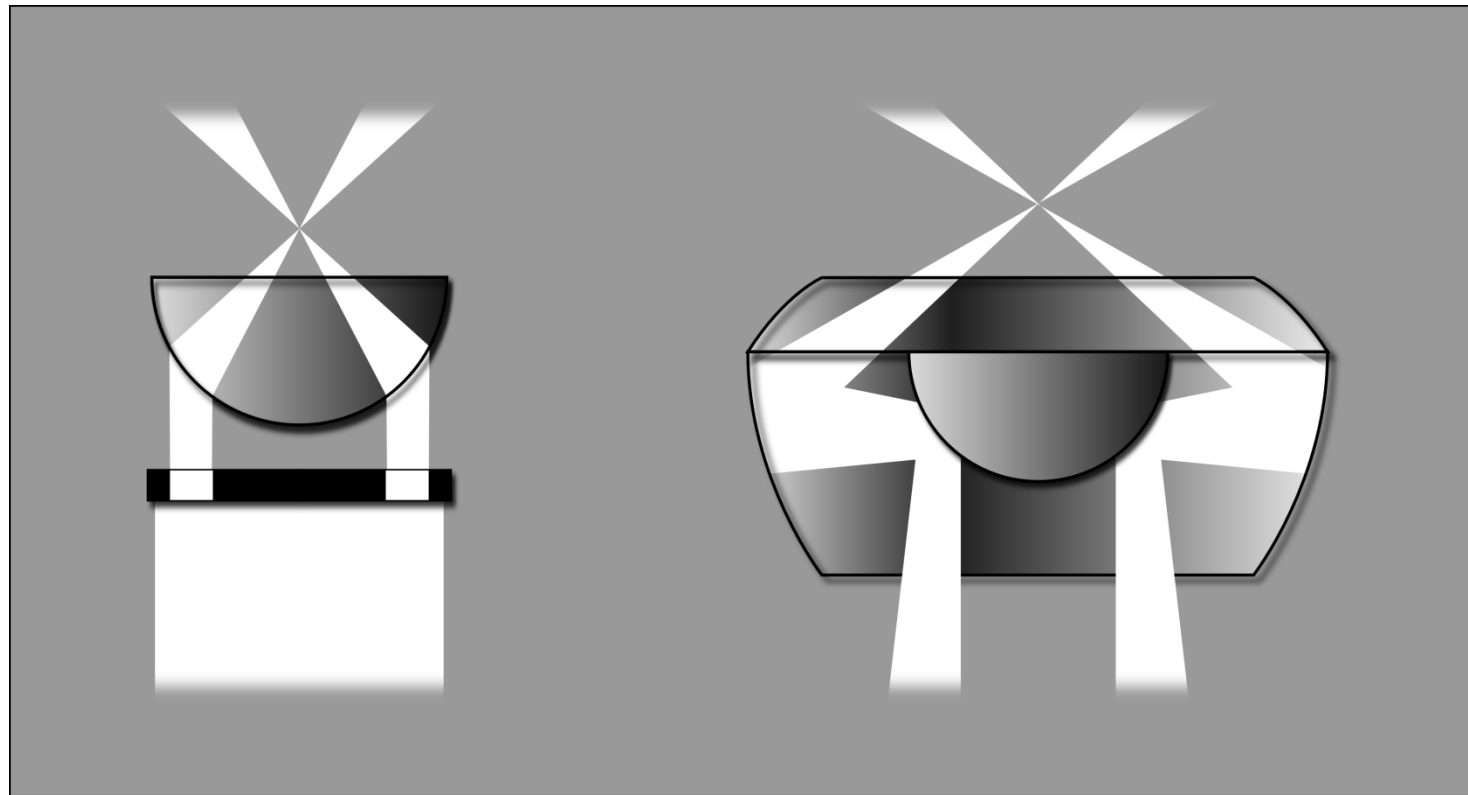

# Darkfield (DF) Microscopy

## Example: Microbiology

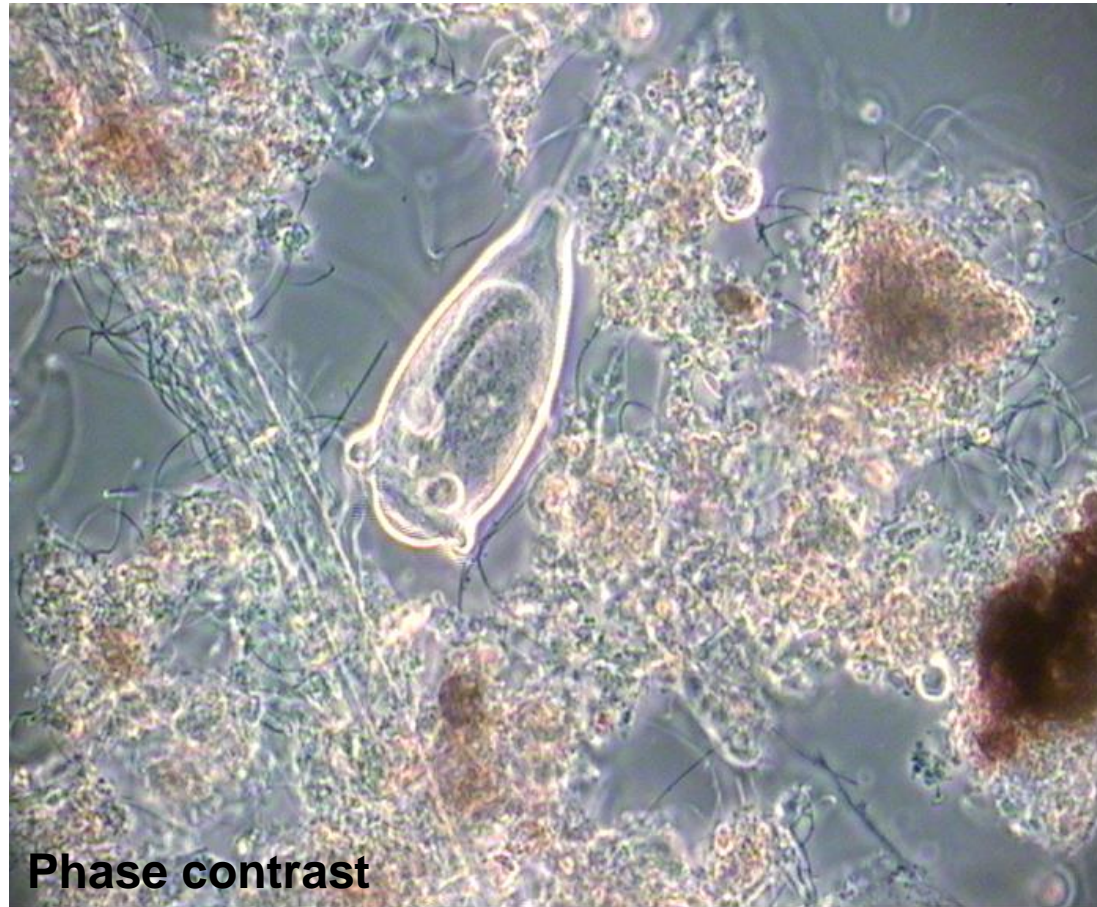

# Darkfield (DF) Microscopy

## Example: Microbiology





# Darkfield (DF) Microscopy

Example: Live blood (1000x, objective with iris diaphragm)

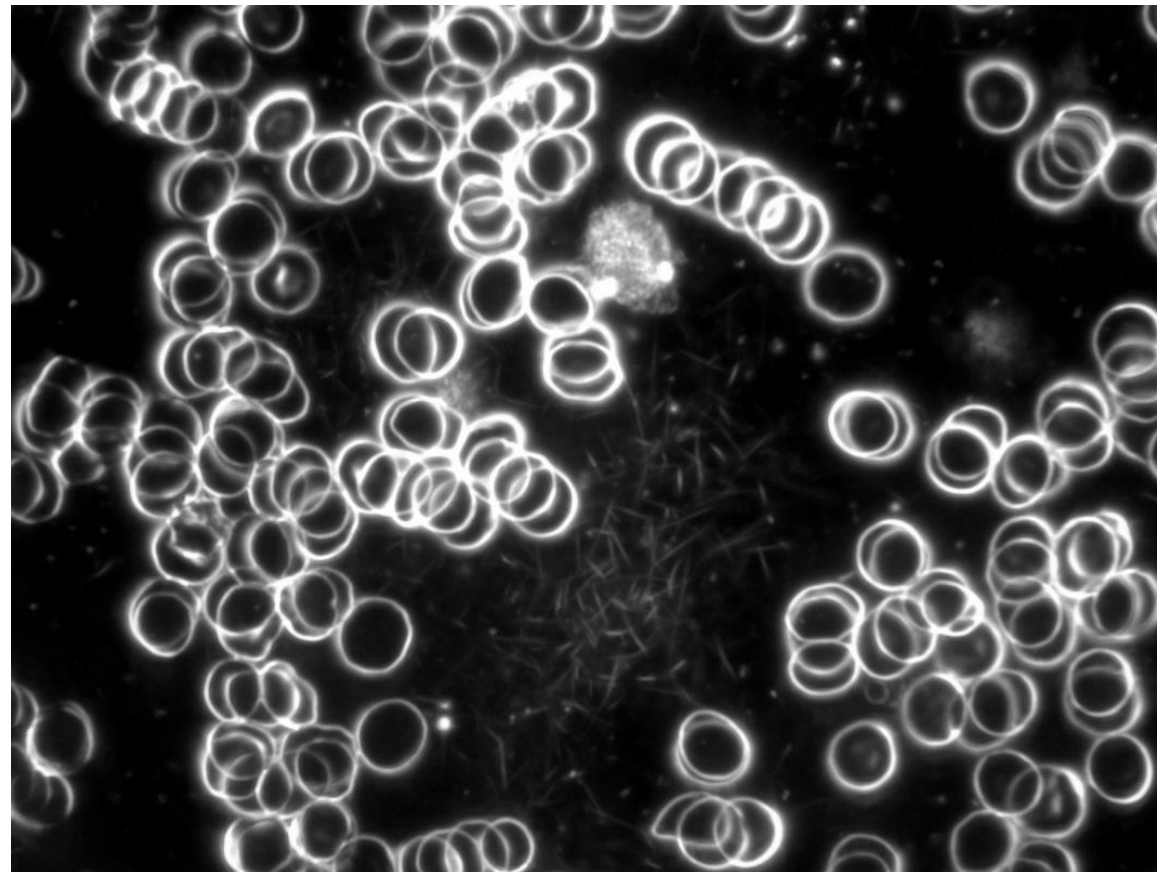

# Darkfield (DF) Microscopy

Example: Stereo microscopy, flexible illumination

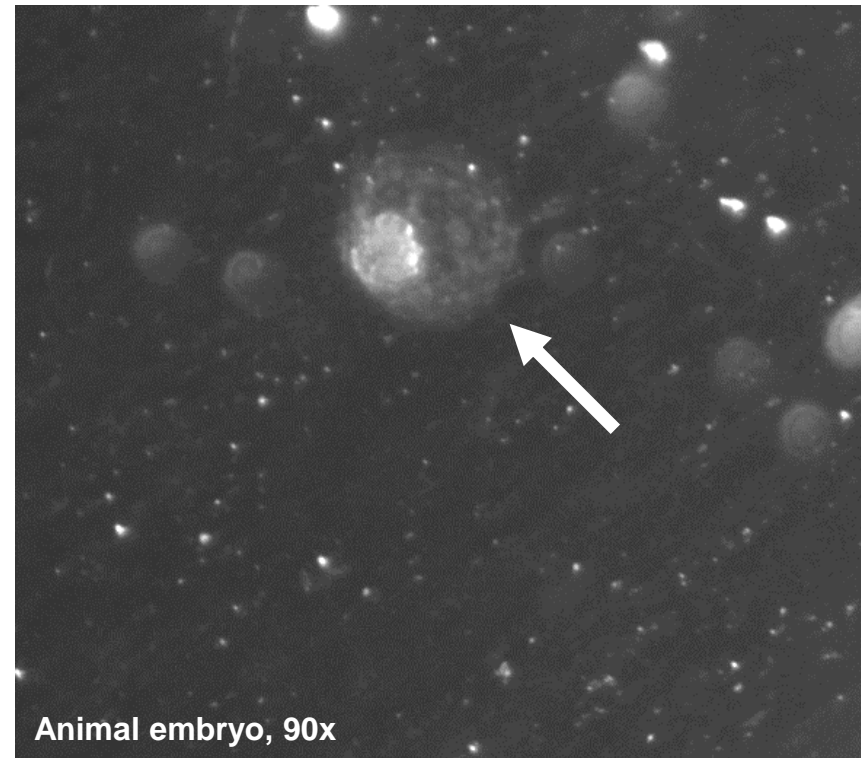



# Polarisation (POL) Microscopy

- Low-contrast specimens
- Staining: not possible
- Example: Examination for gout; mineralogy
- BF microscope with polariser/analyser combination

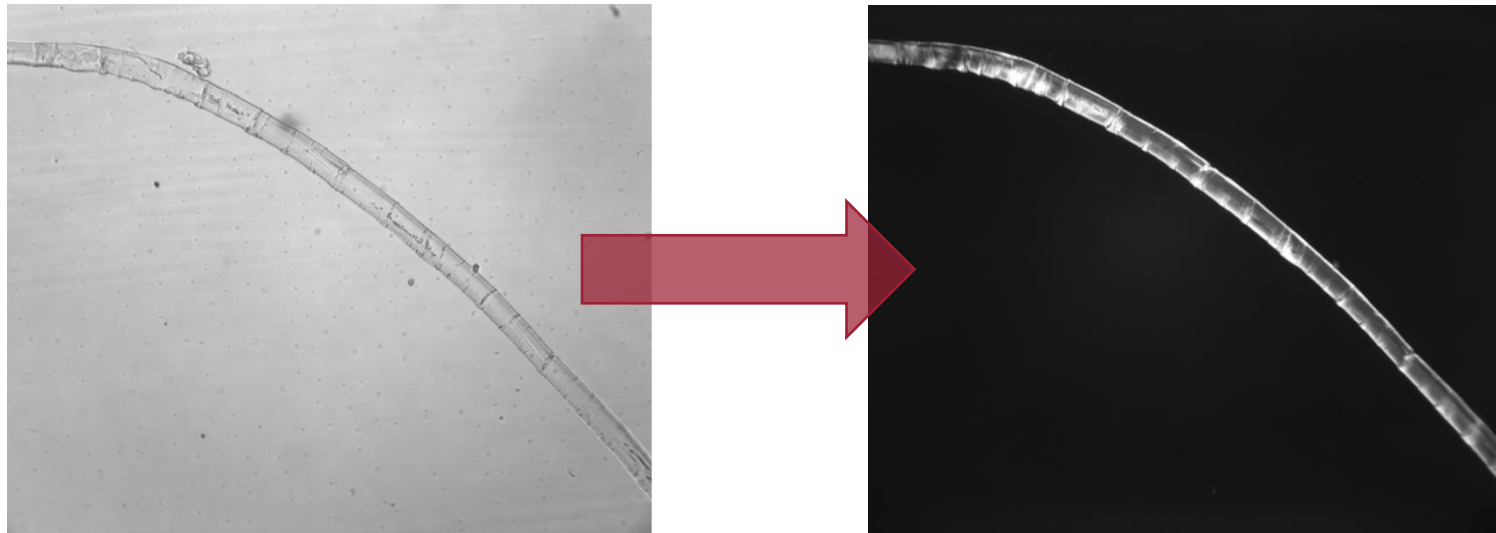

## Contrast through variations in birefringence: **Orthoscopy**

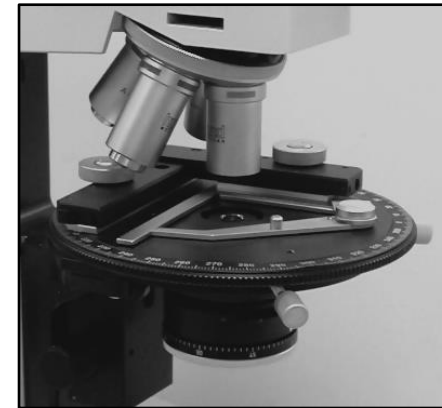
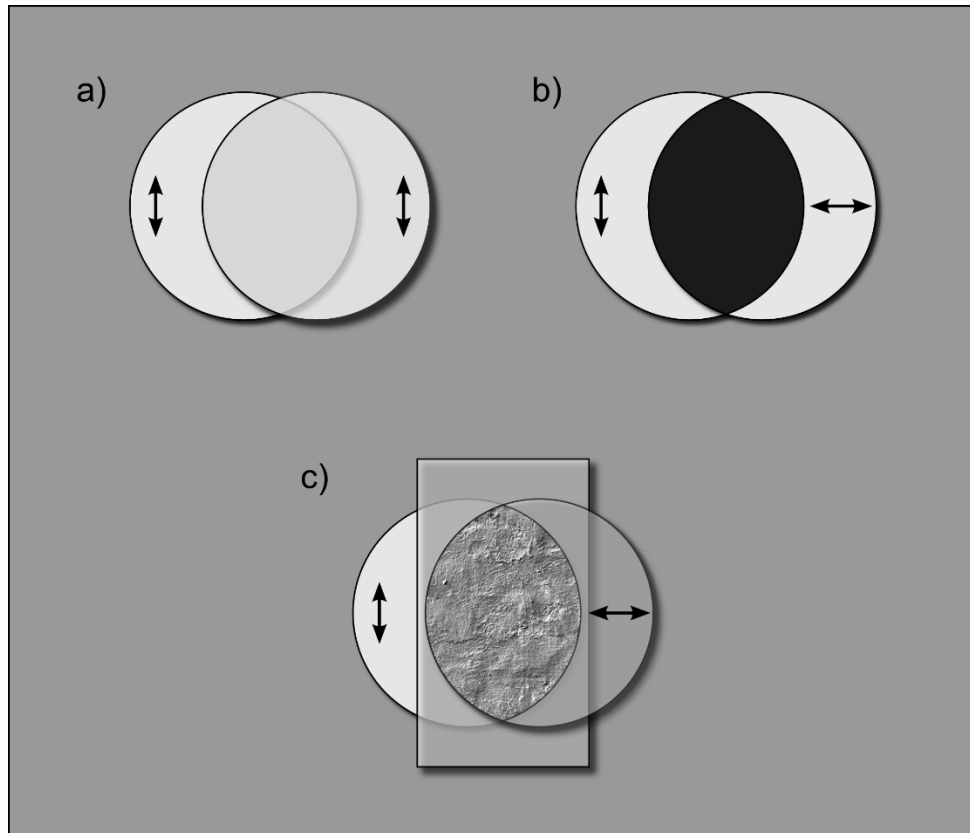

Polariser with rotary table

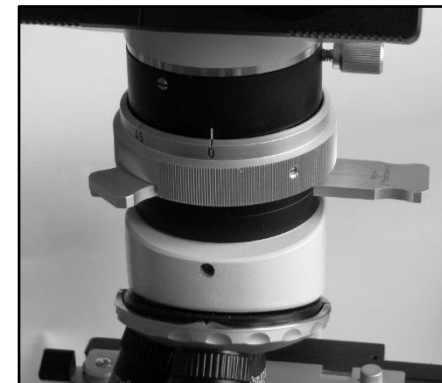

Analyser with compensator

# Polarisation (POL) Microscopy

Example: Potato starch



# Polarisation (POL) Microscopy

Example: Thin section (basalt)

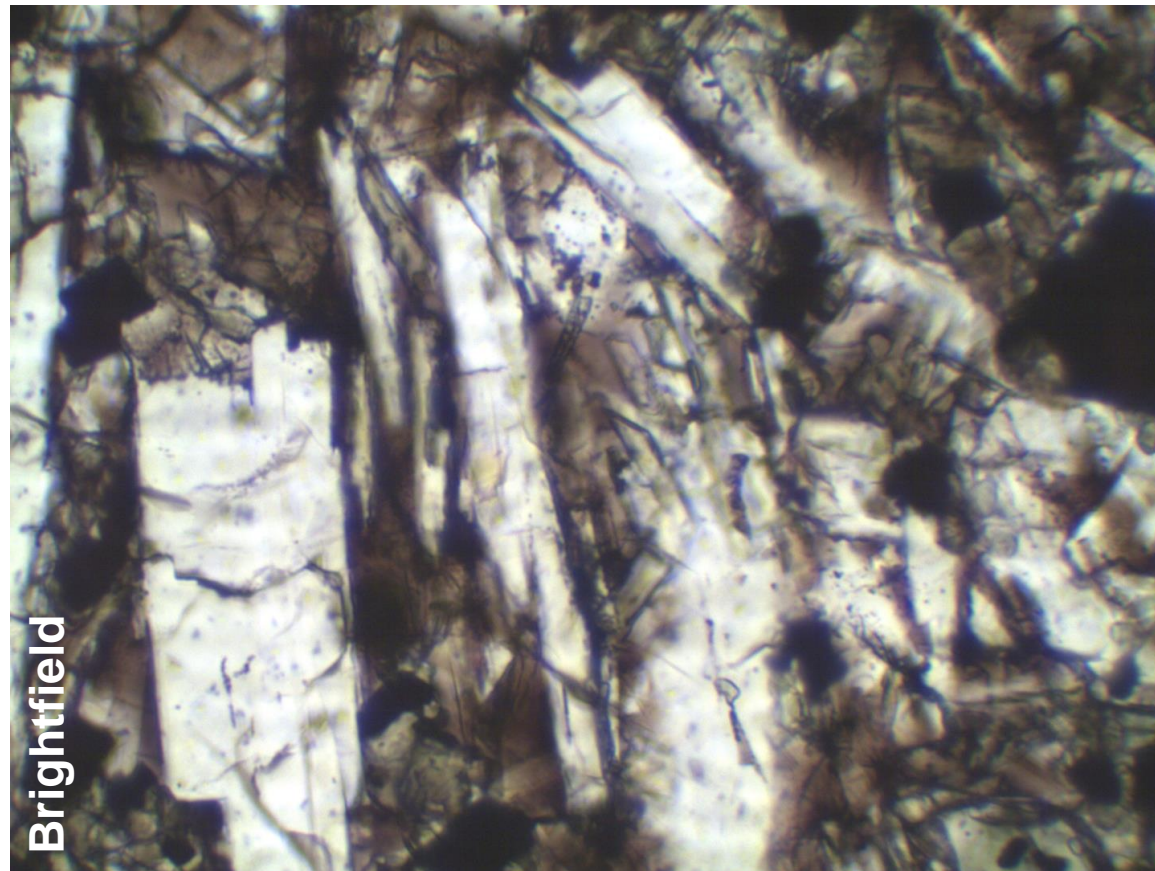

# Polarisation (POL) Microscopy

Example: Thin section (basalt)

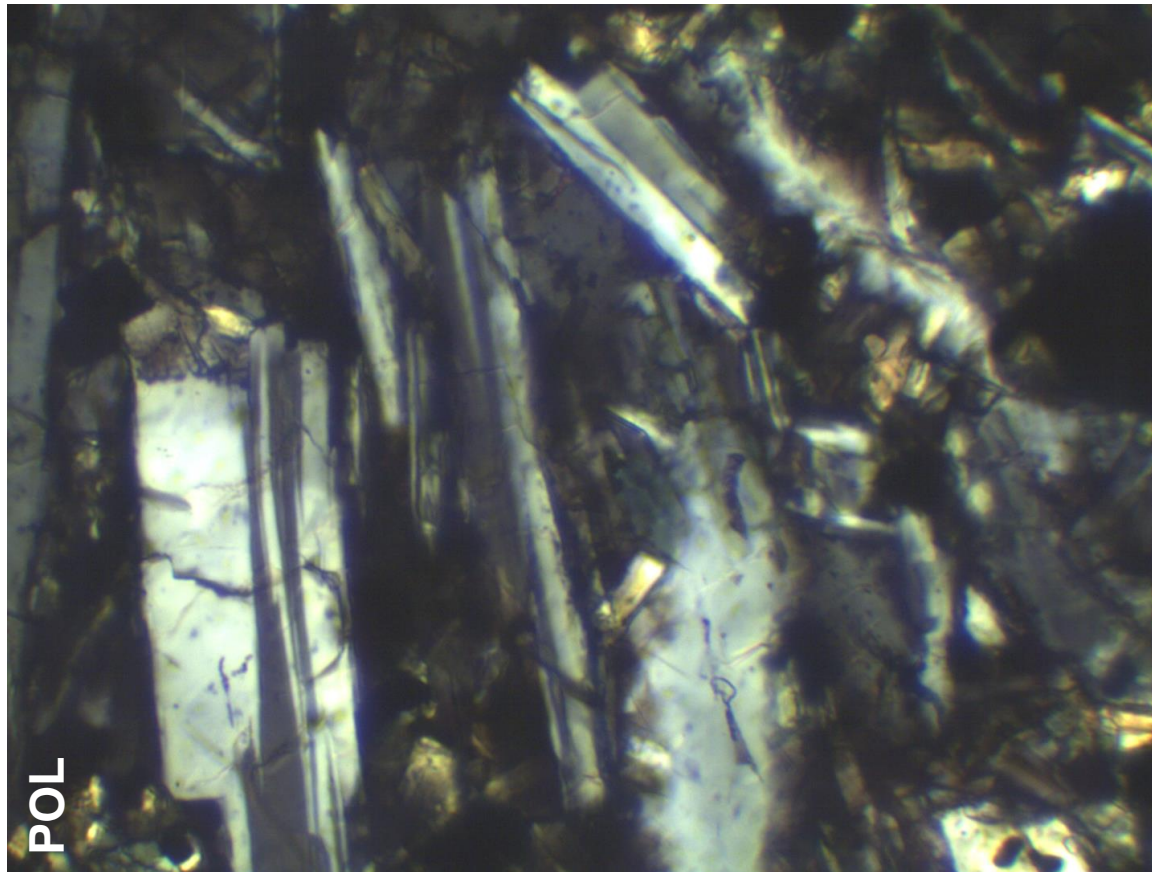



# Polarisation (POL) Microscopy

Example: Thin section (basalt)

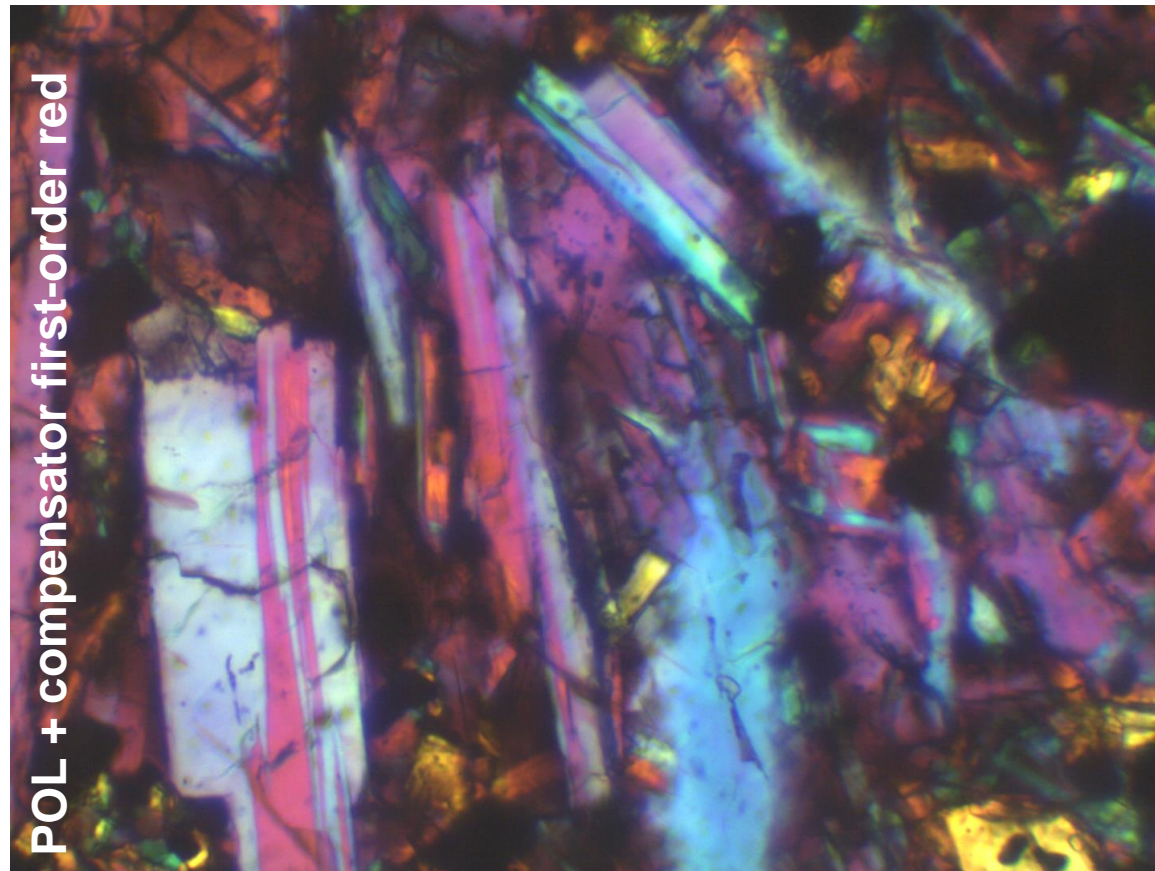



Interferences in back focal plane of objective: **Conoscopy**

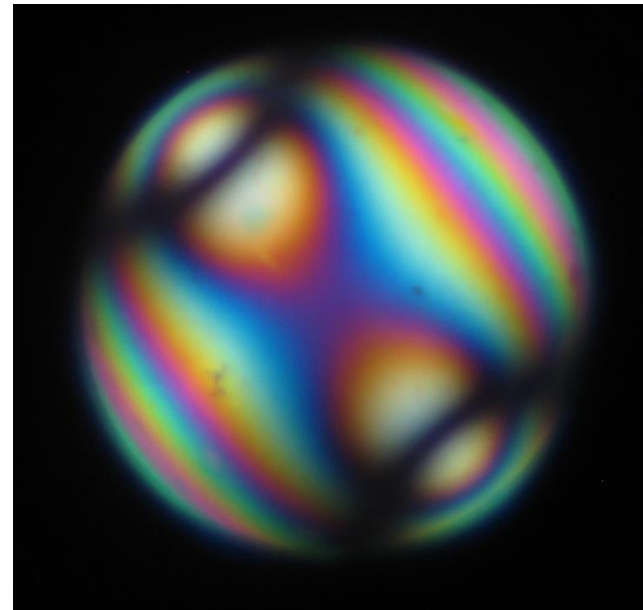
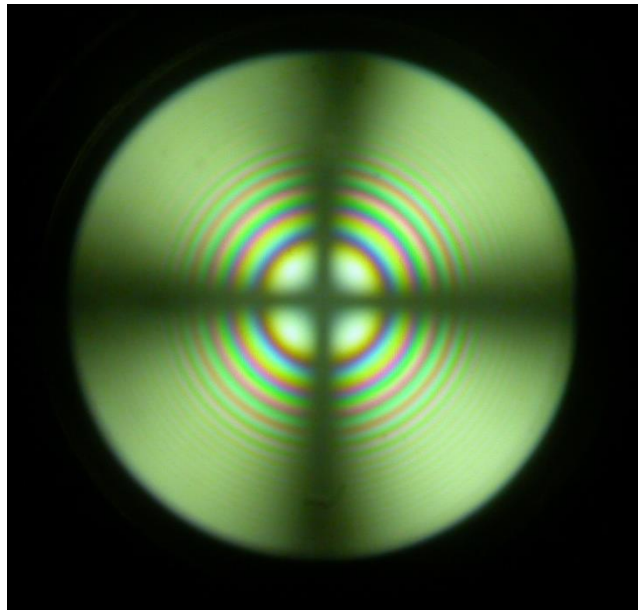

**Accessory: Bertrand lens or (with Hund microscopes) auxiliary microscope**

# Fluorescence (FL) Microscopy

- Extreme specificity: specific detection of pathogens
- Short-wavelength excitation, long-wavelength detection

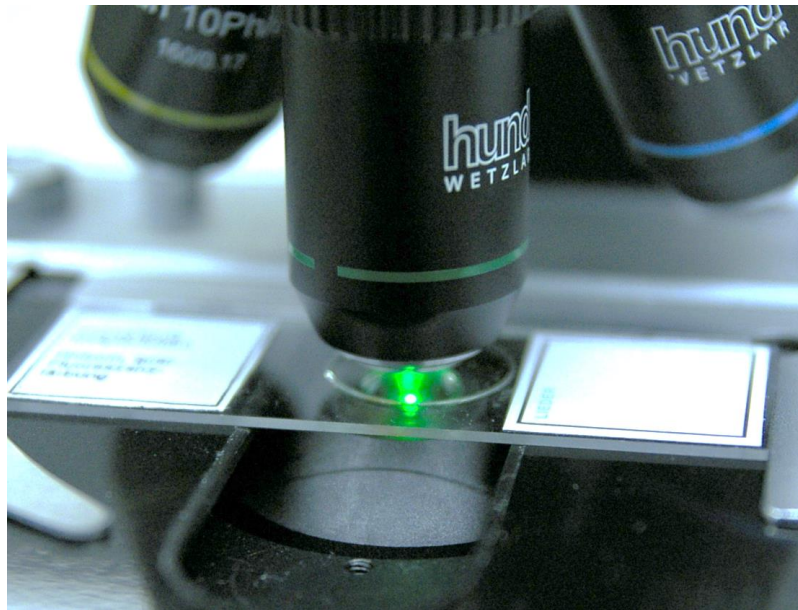

Green excitation (530 nm)

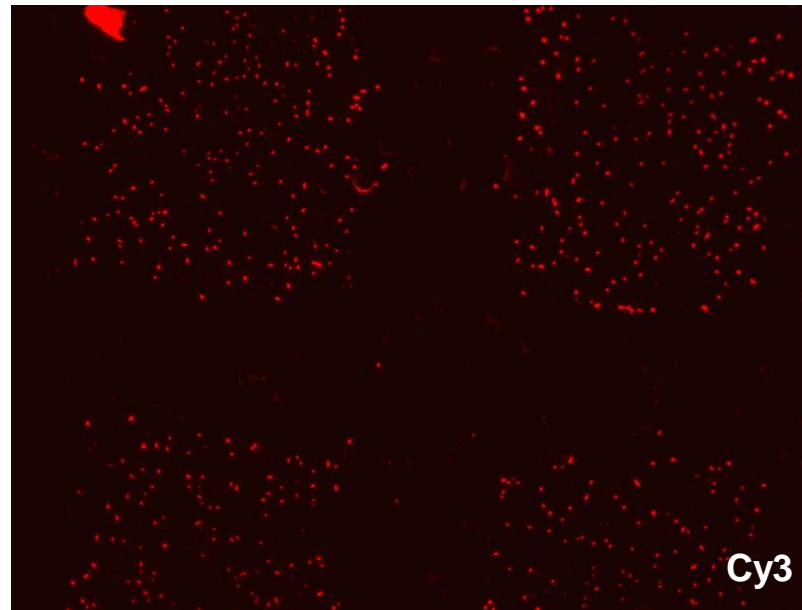

Red fluorescence (> 580 nm)

# Fluorescence (FL) Microscopy

- Extreme specificity: specific detection of pathogens
- Short-wavelength excitation, long-wavelength detection

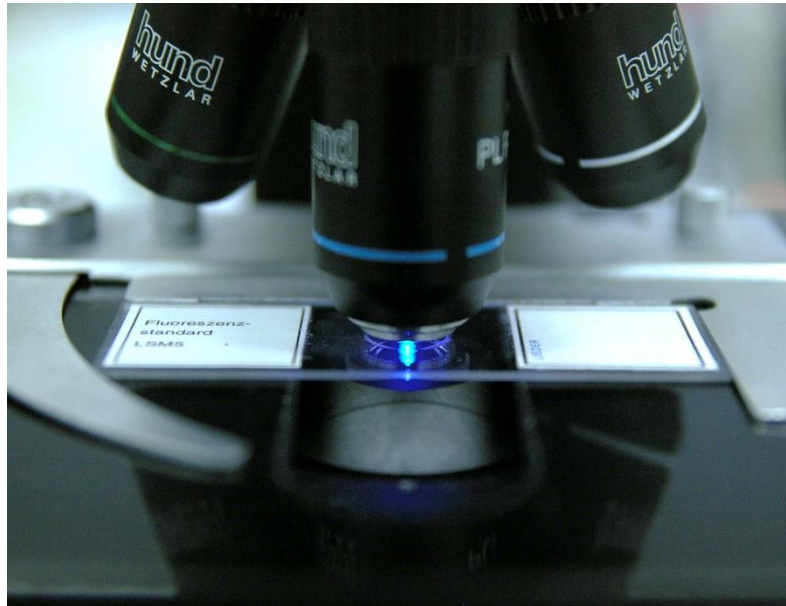

Blue excitation (470 nm)

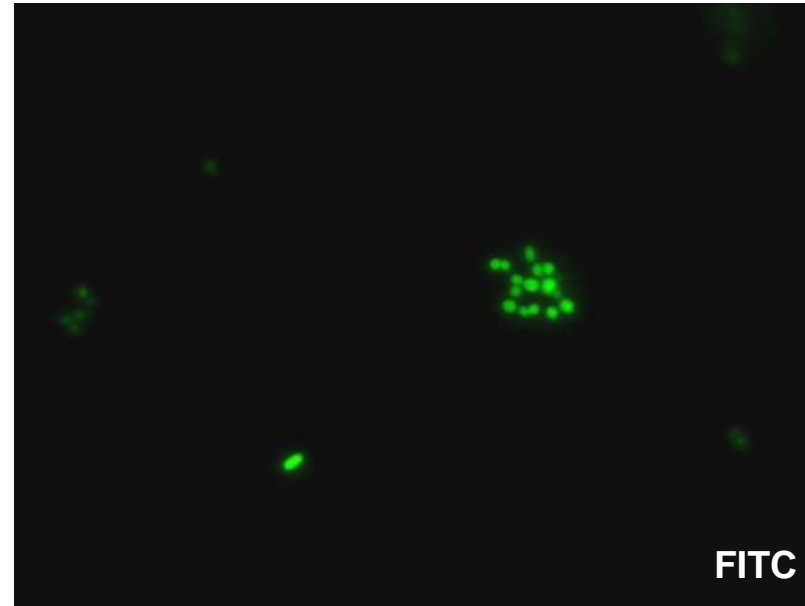

Green fluorescence (> 520 nm)

Mechanism	Description
Primary (auto-) fluorescence	Intrinsic fluorescence of many biological objects, e.g. pollen – also observed with some materials
Secondary fluorescence	After staining with fluorochromes, e.g. Mykonal (chitin, cellulose) or DAPI (DNA)
Immunofluorescence	After coupling with fluorochrome-labelled antibodies, VERY specific. Example: FITC, TRITC

# Fluorescence (FL) Microscopy

Examples:

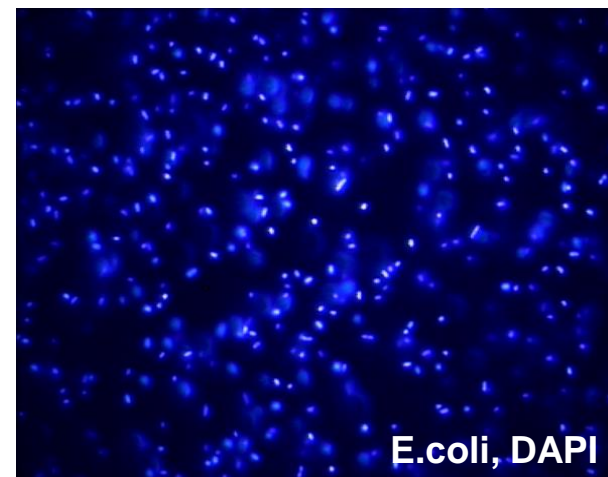
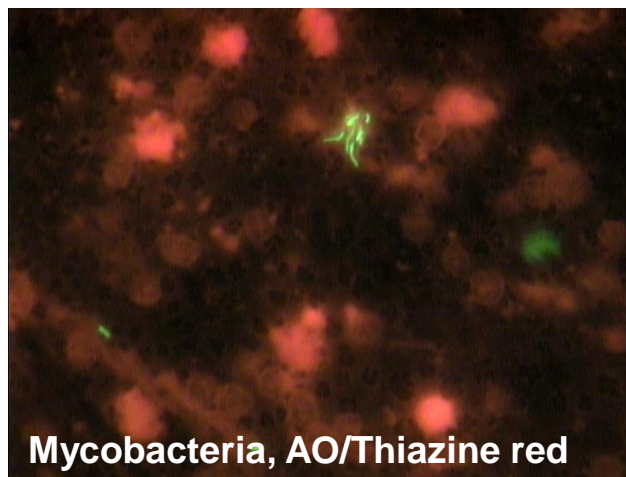
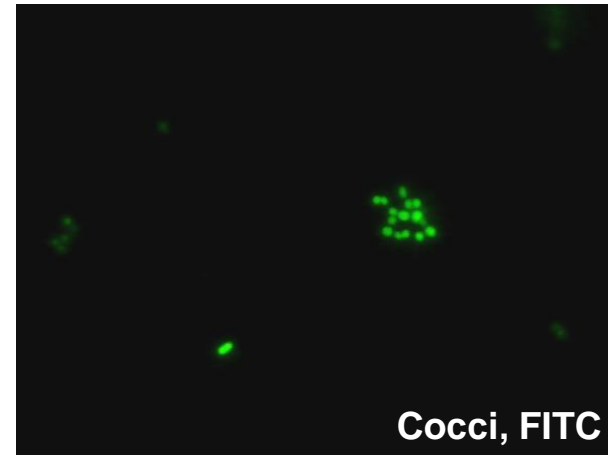



Fluorochrome **Mykoval** (Hund): Mycoses, yeasts, parasites

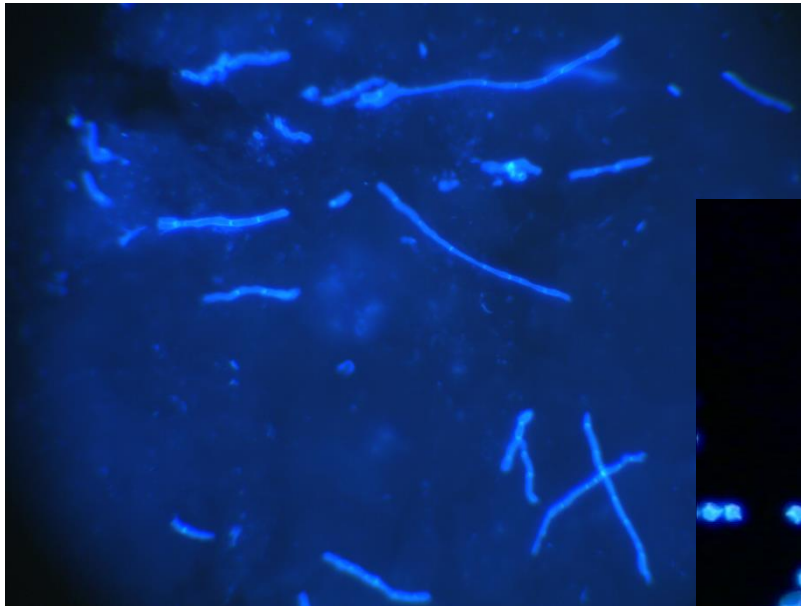

Skin scale with dermatomycosis



Penicillium spp. from adhesive film test

# Fluorescence (FL) Microscopy

## Incident-light illumination (HBO) with special filter sets

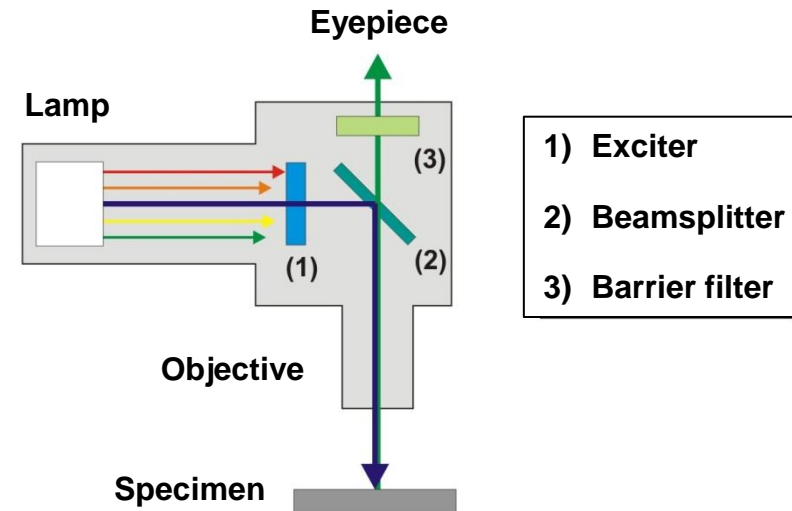

# Fluorescence (FL) Microscopy

## Incident-light illumination (LED) with special filter set

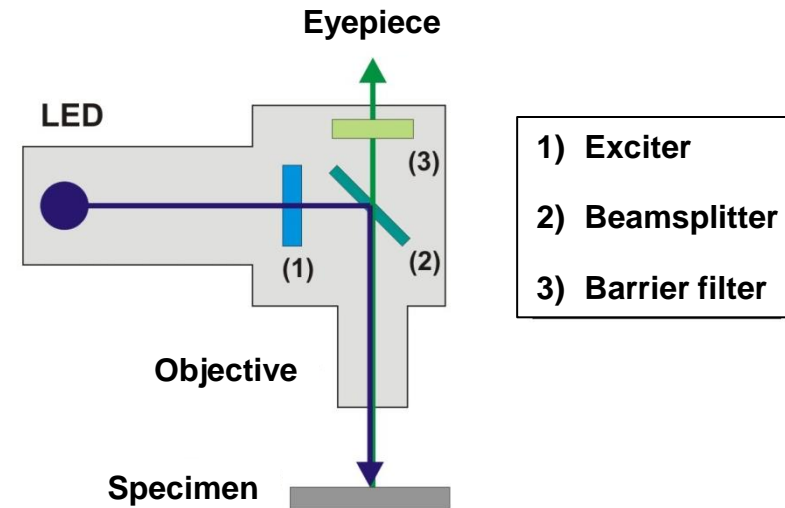

## Advantages:

- Native specimens: Fast results
- High diagnostic reliability
- Little expert knowledge necessary

## Application of Mykoval

- Nativ specimens: Skin, hair, nails, mucous smears
- Histological specimens: Combined stainings
- Rapid diagnostics during surgical operations
- Body fluids, stool
- Gynaecology: Yeast colonies on mucous membranes
- Microsporidia in stool



## Combined staining: Mykoval + HE

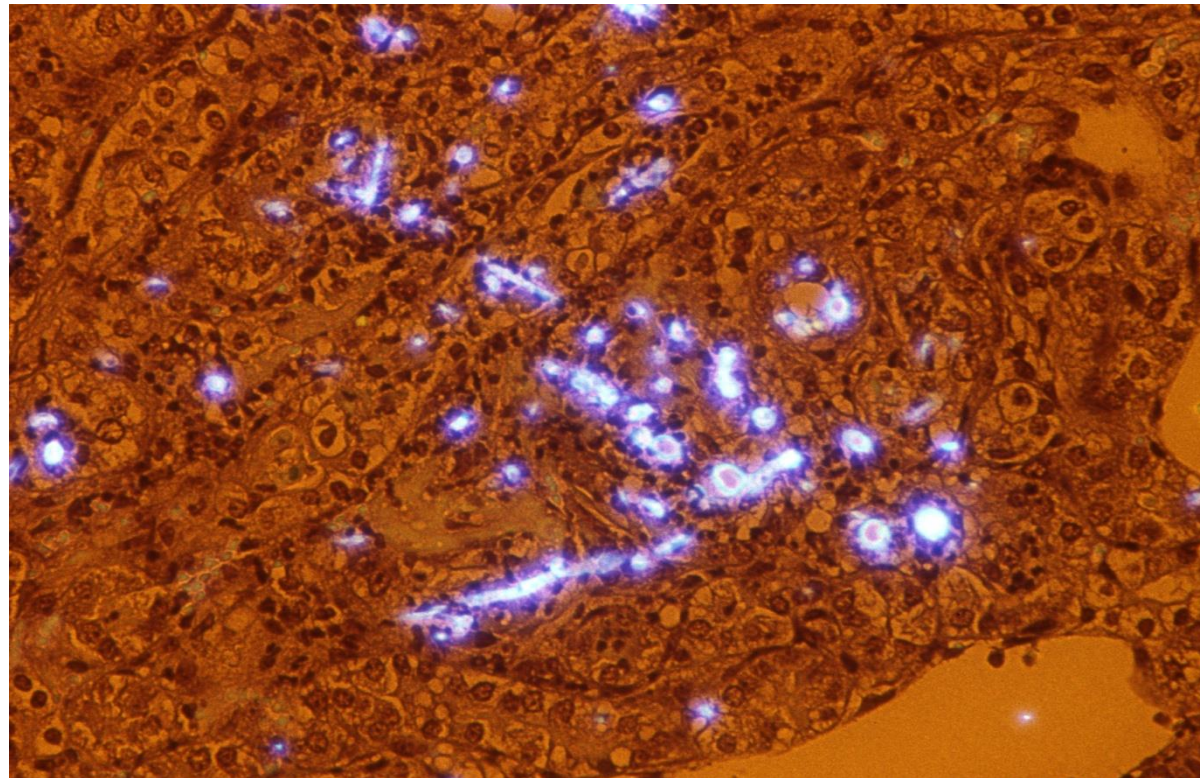

Mouse, candidosis of the kidney, brightfield/fluorescence

Combined staining: FAM + Cy3 (Vermicon)

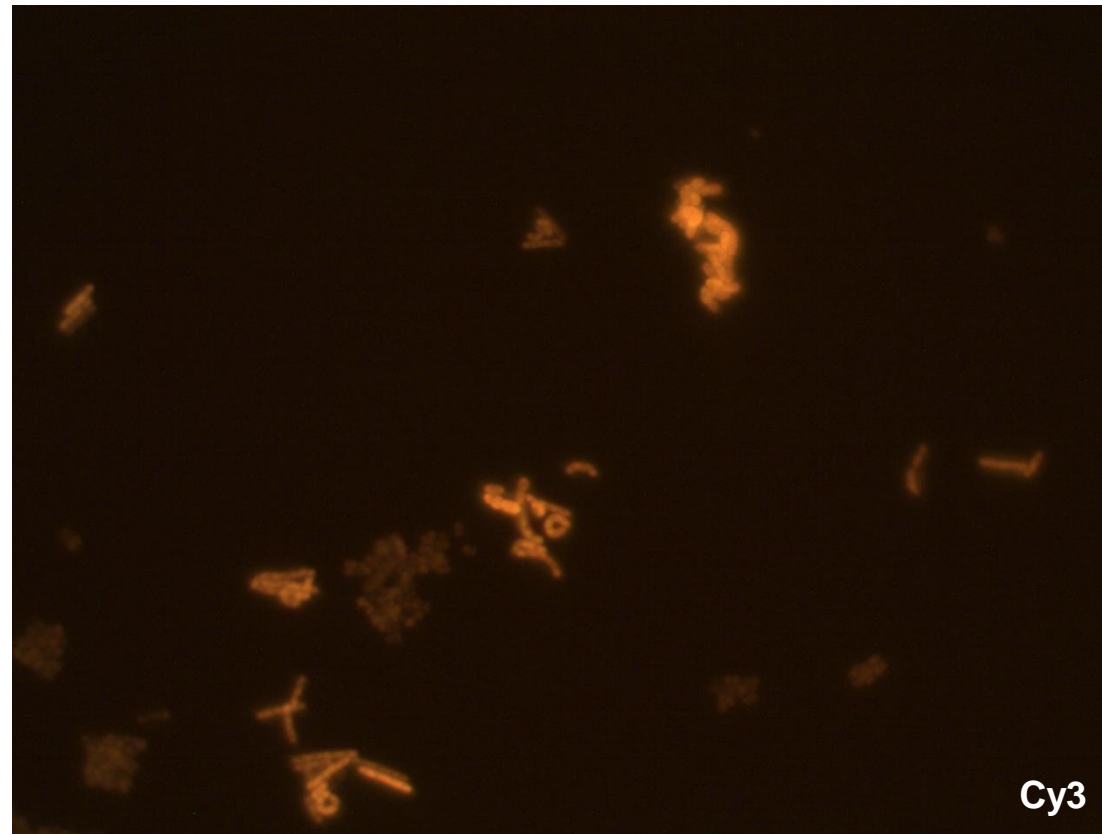

Red: beer spoilage bacteria

Combined staining: FAM + Cy3 (Vermicon)

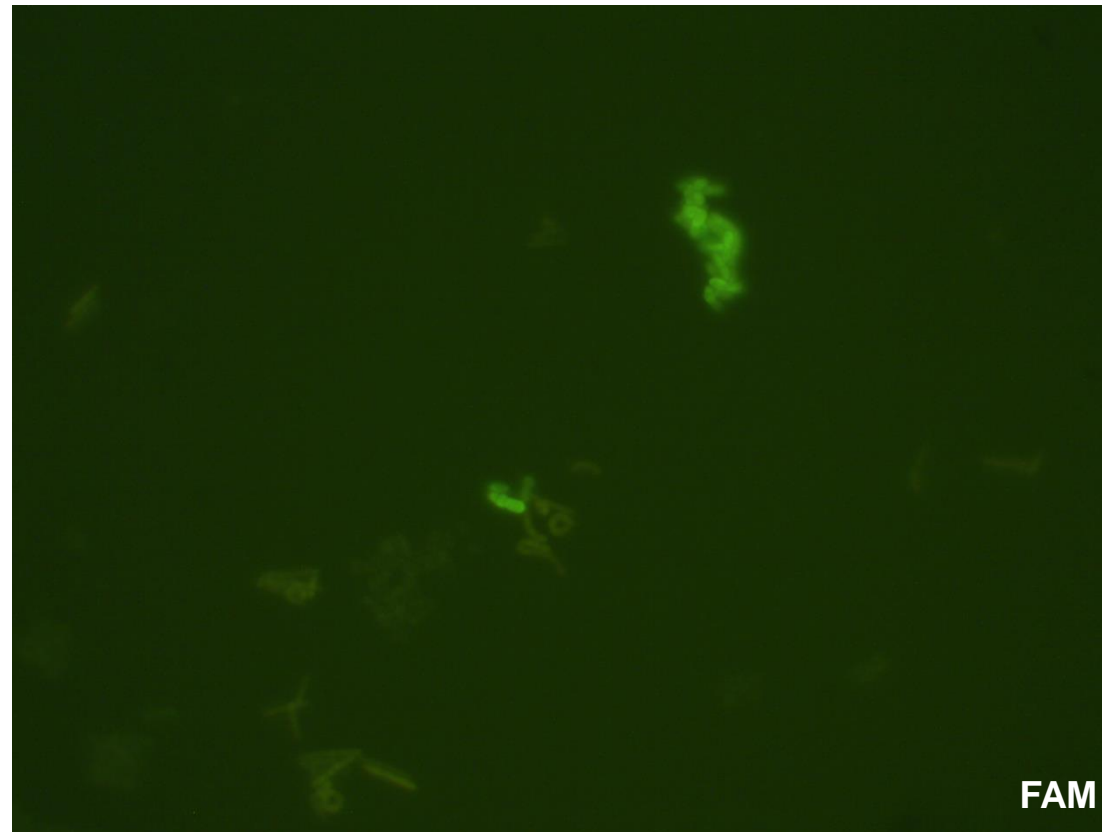

Green: *Lactobazillus brevis*

## Brightfield – Fluorescence (Mykoval)



## Brightfield – Fluorescence (Mykonal)

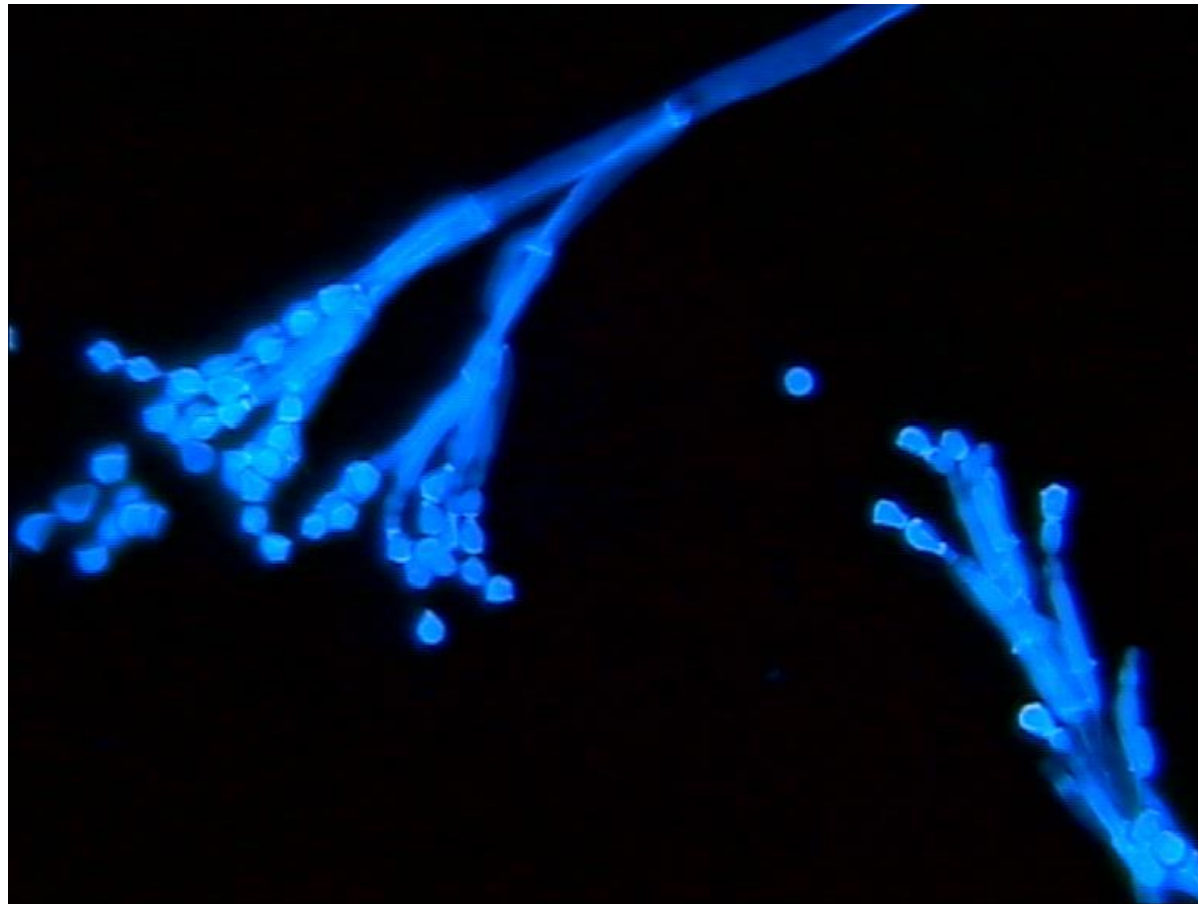



## Brightfield – Phase contrast – Fluorescence (Mykoval)



## Brightfield – Phase contrast – Fluorescence (Mykonal)



## Brightfield – Phase contrast – Fluorescence (Mykonal)

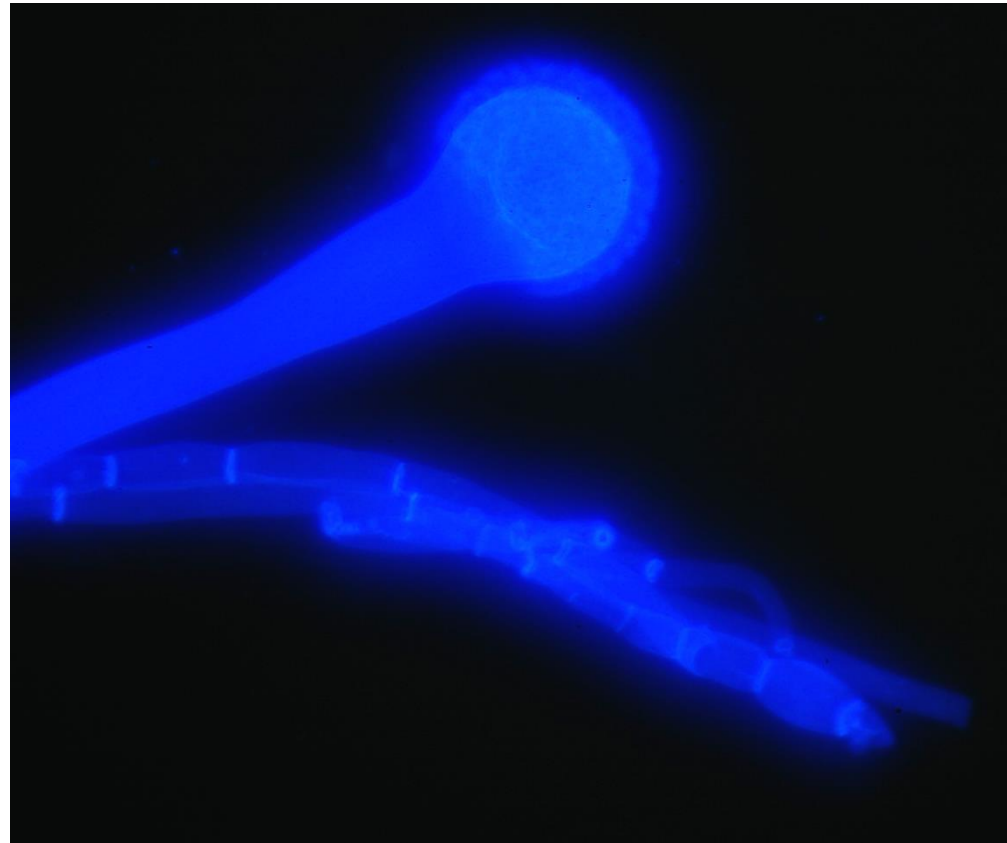

## Brightfield – Phase contrast – Fluorescence (Mykonal)



# Components of a Microscope

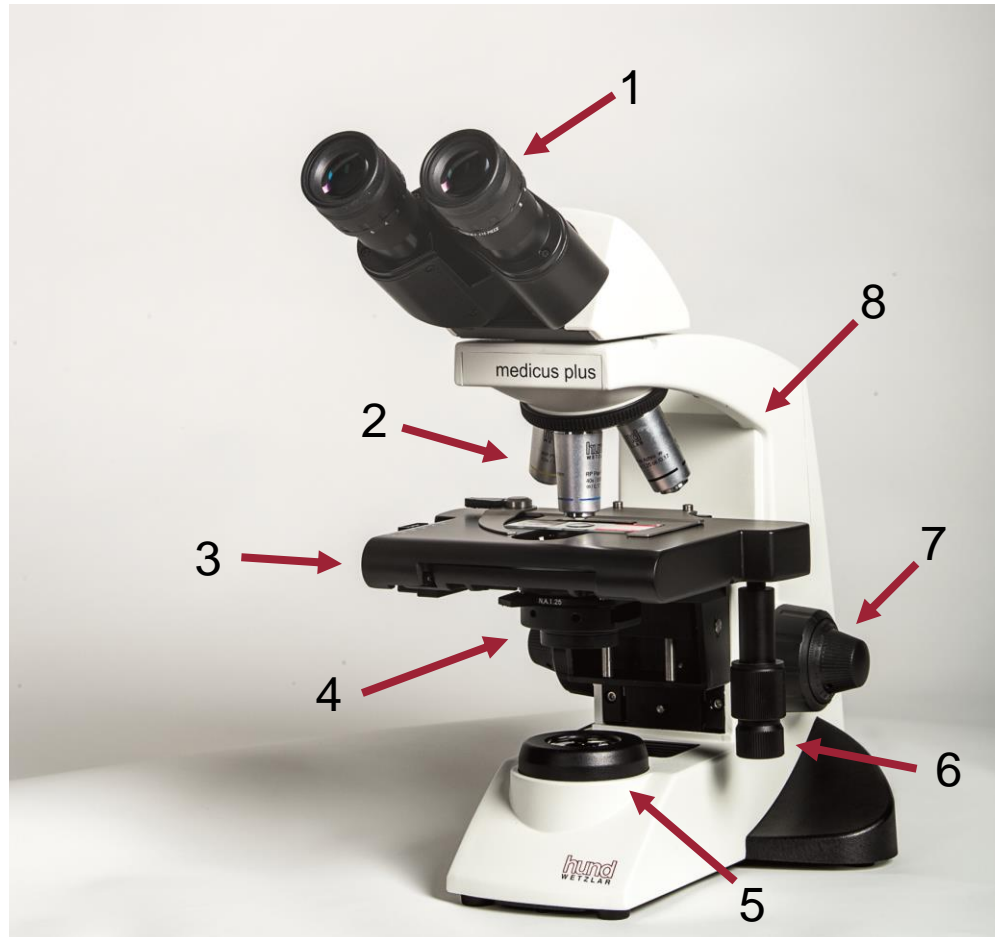

- 1:** Eyepieces and tube
- 2:** Nosepiece with objectives
- 3:** Microscope stage
- 4:** Condenser with diaphragm
- 5:** Illumination
- 6:** Stage drive (x/y)
- 7:** Focus drive (coarse/fine)
- 8:** Stand





- For doctor's surgeries and education in biology
- Compact, robust design
- Long-life LED illumination
- Flat microscopic image: plan achromatic objectives 4x, 10x, 40x, 100x Oil
- Effortless operation through adjustable friction of coarse focus drive
- Attractive price
- Fixed configuration

# medicus plus: Versatility



- For doctors' surgeries, medical and biological laboratories
- Compact, ergonomical design
- Low risk of injury due to rackless stage drives
- Flat microscopic image: plan achromatic objectives
- Counting chambers possible (BF)
- Effortless operation through adjustable Siedentopf tube
- Easy adaptation of cameras for documentation purposes
- Versatile accessories



- For doctors' surgeries, medical and biological laboratories
- Compact, ergonomical design
- Low risk of injury due to rackless stage drives
- Plan achromatic objectives
- Variable colour temperature
- „Light Memory“
- Counting chambers possible
- Effortless operation through adjustable Siedentopf tube
- Easy adaptation of cameras for documentation purposes
- Versatile accessories



- Configuration medicus pro Myko
- Target group: Dermatologists, allergists, gynaecologists, building biologists
- No cultivation necessary
- Simple staining of the specimen with Mykoyal
- Reliable diagnosis due to high contrast and high resolution
- UV protection shield
- Optical switch BF/FL
- Long lifetime of LED illuminator
- Easy retrofit of the illuminator to already existing medicus pro

# H 600: High Flexibility



- For doctors' surgeries and clinical labs
- Sturdy, universally expandable microscope stand
- Nosepiece for up to 5 objectives
- Combination condensers for rapid switching between BF, DF, PH
- Components for high-resolution darkfield observations available
- Tungsten halogen or LED illumination, alignment acc. to Köhler
- Simple adaptation of cameras for documentation purposes
- Versatile accessories



# H 600: Lots of Options

**H 600 LL HP 100**



**H 600 HP LED**



**H 600 LED-AFL Myko**



**H 600 AFL Plan 100**



# Wilovert: The inverted Microscope

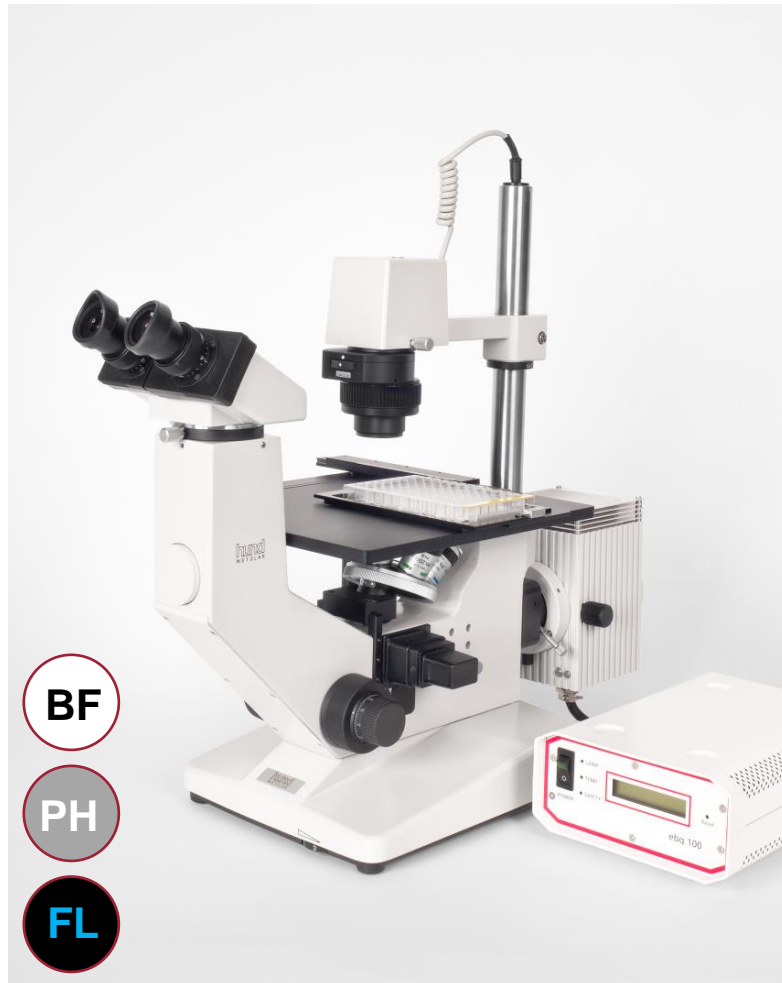

- For clinical and cell culture labs
- Sturdy, universally expandable microscope stand
- Nosepiece for up to 5 objectives
- Combination condensers for rapid switching between BF, PH
- Stand for incident-light fluorescence available
- Adapters for various sample vessels available
- Simple adaptation of cameras for documentation purposes
- Adaptation of micromanipulators possible

# Wiloskop: The Stereo Microscope



- For dissection, workshops, education and school labs
- Continuous zoom: 6.7x – 45x (with eyepieces 10x)
- Expandable with eyepieces and auxiliary lenses
- Various stands and illumination configurations
- Cold-light tungsten halogen lamps with various light guide configurations available
- White-light LED ring with variable illumination geometry available
- Simple adaptation of cameras for documentation purposes

# Cameras for Microscopy



	UI-1240LE-C	UI-3580SE-C
<b>Chip size</b>	1/1.8"	1/2"
<b>Sensor type</b>	CMOS	CMOS
<b>Resolution [pixels]</b>	1280 x 1024 (1.31 MPix)	2560 x 1920 (4.92 MPix)
<b>Frame rate [fps]</b>	25.8	15.2
<b>Colour depth [Bit]</b>	8	12
<b>Interface</b>	USB 2.0	USB 3.0
<b>Software</b>	uEye Cockpit	
<b>C-Mount adapter</b>	0.5x	0.5x
<b>Windows version</b>	10	

# Software: uEye Cockpit

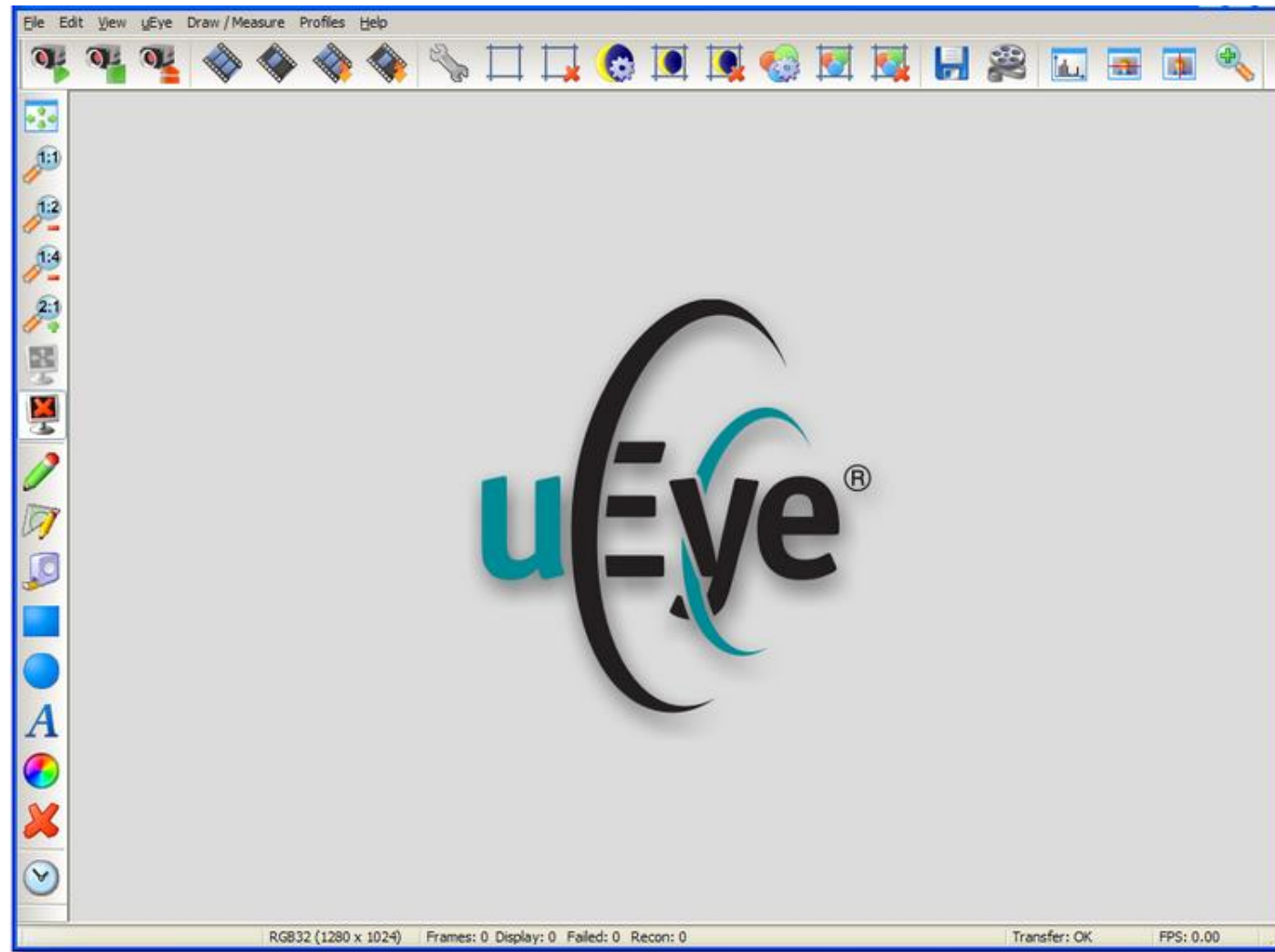



# Measurement System: pixel-fox

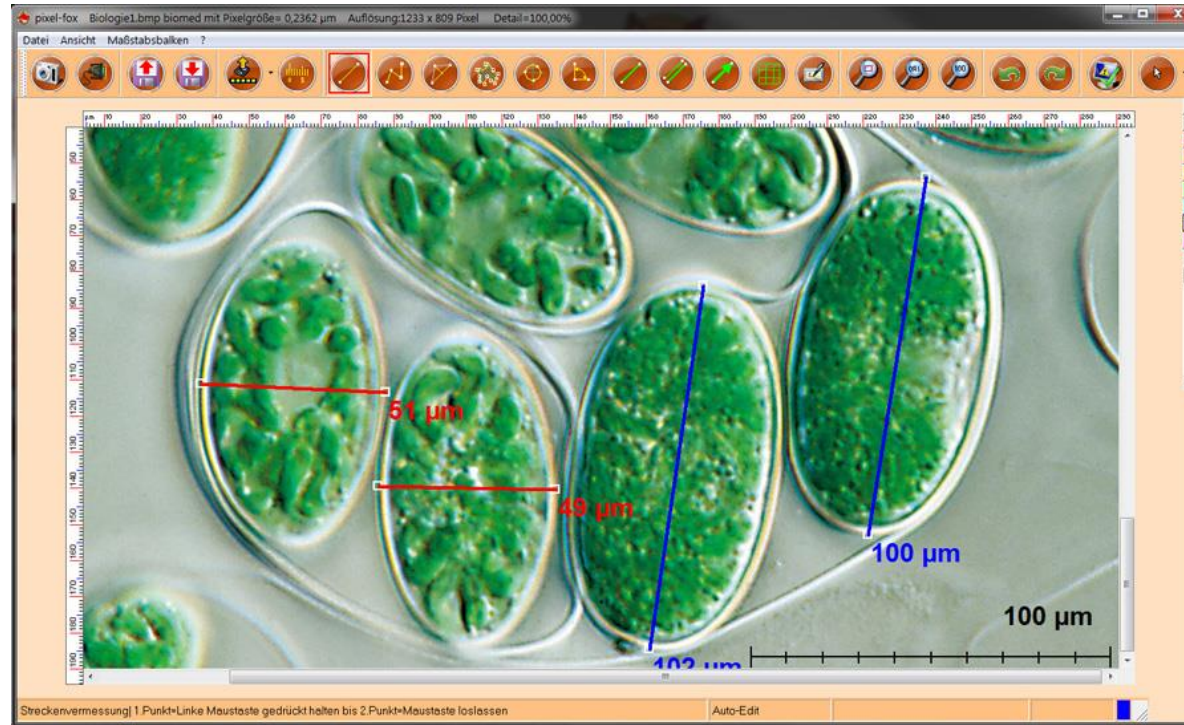

# All our Microscopes are IVDs

**hund**  
WETZLAR

Wir bringen Technologien zusammen. Optik – Elektronik – Feinmechanik

## EG Declaration of Conformity

**Helmut Hund GmbH, Artur-Herzog-Str. 2, D-35580 Wetzlar-Nauborn, Germany**  
(QM system certified to meet ISO 9001:2008, DIN EN ISO 13485:2012)

We hereby declare that the device is compliant with Directive 98/79/EC of the European Parliament and of the Council on In-Vitro Diagnostic Devices. This declaration is valid for all devices manufactured before March 31, 2022. The conformity assessment procedure was carried out according to Annex III of said directive. This declaration becomes void for all modifications of the device that are not authorized by us.

**Product Description:** Upright Microscope

**Type:** Laboratory Microscope medicus plus



**Artikelnummer(n):** medicus plus/Bino (Art. No. 008.0445.0)  
medicus plus/Trino (Art.-Nr. 008.0449.0)  
medicus plus/Bino/LED/Köhler (Art.-Nr. 008.0444.0)  
medicus plus PH/Bino (Art.-Nr. 008.0447.0)  
medicus plus PH/Trino (Art.-Nr. 008.0448.0)  
medicus plus Myko (Art.-Nr. 008.0452.0)



- Microscopes for diagnostic purposes and for samples of human origins are **in-vitro diagnostic devices (IVDs)**
- Hund laboratory microscopes are labelled as IVDs
- Corresponding **declarations of conformity** are available upon request

# Ansprechpartner

 Marleen Geller  
Sales Manager Instruments  
 Tel. +49 (0) 6441 2004-36  
 [m.geller@hund.de](mailto:m.geller@hund.de)

 Dr. Jörg Haus  
Product Manager  
 Tel. +49 (0) 6441 2004-28  
 [j.haus@hund.de](mailto:j.haus@hund.de)

 Petra Hertstein-Hecker  
Customer Service  
 Tel. +49 (0) 6441 2004-26  
 [p.hertstein-hecker@hund.de](mailto:p.hertstein-hecker@hund.de)

 Michael Wagner  
Service Microscopy  
 Tel. +49 (0) 6441 2004-51  
 [m.wagner@hund.de](mailto:m.wagner@hund.de)



Web: [www.hund.de](http://www.hund.de)  
Twitter: [www.twitter.com/hund\\_wetzlar](https://www.twitter.com/hund_wetzlar)



Artur-Herzog-Straße 2  
35580 Wetzlar